

Hurd[™]

Clad Casement Windows Parts Catalog

*Clad Wood (Parts for Units Prior to 2005) &
Clad Wood Energy Saver (Parts for Units 2005 to present
Casement Windows*

Cover

Operating Casement Shown from the Interior



Please Note: When ordering Parts, Complete Sash or Complete Frame Window units, Please View from the EXTERIOR Looking in.

The easiest way to determine whether you have a left or right handed unit is by the location of your lock as you are on the inside of the building looking out.

If your lock is on the left hand side of your unit when you are unlocking to open your window then it is a left handed unit. Lock on the right side is a right handed unit.

Table of Contents

	<u>Page</u>
List of Parts	CCSE-2
Operating Sash Exploded View	CCSE-3
Operating Sash Elevation & Cross Section Views	CCSE-4
Operating Frame Exploded View	CCSE-5
Wood Stops	CCSE-6
Hardware / Miscellaneous	
Casement Hardware, Frame & Sash	CCSE-10
Casement Hardware (Encore & DLX)	CCSE-11
Casement Hardware (Encore) 9/19/2005 to Present	CCSE-12
Casement Hardware (DLX) 2/2/98 to 9/19/2005	CCSE-13
Casement Hardware (1988 to 2/2/1998)	CCSE-14
Casement Hardware (Prior to 1988)	CCSE-15
Fastener Schedule	CCSE-30
Hardware / Weatherstripping / Miscellaneous	CCSE-16
	CCSE-17
	CCSE-18
Arm/Track Kits Hardware (Prior to 02/02/1998)	CCSE -15
Sash Assembly Order Pages	CCSE-19
Stationary Picture SNF Section Details & Formulas	CCSE-20
Stationary Picture SNF; Frame Exploded View/Glass Sizes	CCSE-21
Glazing Bead	CCSE-22
Screens w/ Lift Rail 01/1998 to Present	CCSE-23
Screens w/ Plunger 01/1998 & Prior	CCSE-24
Glass	CCSE-25, 26, 27
Grille Parts	CCSE-28, 29
Notes Pages/Application of Limit Device	CCSE-30



Tech Tip:

When you see this symbol you will find technical information advice about the part.

Clad Wood Casement Windows Replacement Parts



Parts Shown on Exploded Views:

Parts List

Item No .	Description	Part Found On:
1.	Operating Wood Sill Stop, Upper Section - Frame,	CCSE-6
2.	Operating Wood Sill Stop, Lower Section - Frame,	CCSE-6
3.	Sill Stop Blocks	CCSE-6
4.	Hinge Side Wood Stop	CCSE-6
5.	Lock Side Wood Stop	CCSE-7
6.	Lock Side Support Stops	CCSE-7
7.	Operating Wood Head Stop	CCSE-7
8.	HingeTrack	CCSE-15
9.	Hinge Arm	Sash, CCSE-3, CCSE-15
11.	Dual Arm Operator	Frame, CCSE-5, CCSE-12
12.	Encore Handle	Frame, CCSE-5, CCSE-12
13.	Sash Bracket	Sash, CCSE-3, CCSE-12, CCSE-14
14.	Lock Handle	Frame, CCSE-5, CCSE-11
15.	Keeper	Sash, CCSE-3, CCSE-11
16.	Lock Escutcheon	Frame, CCSE-5, CCSE-11
17.	Tie Bar w/ Link & Guides	Frame, CCSE-5, CCSE-10
18.	Dual Arm Sash Track	Sash, CCSE-3, CCSE-11
19.	Dual Arm Sash Track Shoe	Sash, CCSE-3, CCSE-11
20.	Snubbers	Frame / Sash, CCSE-3, CCSE-5, CCSE-10
21.	Encore Operator Cover	Frame, CCSE-5, CCSE-12
22.	Sash Lift Block	Sash, CCSE-3, CCSE-16
23.	Nailing Fin Corner Pads	CCSE-5, CCSE-16
24.	Offset Bulb Weatherstrip	CCSE-3, CCSE-16
25.	Sill Folding Nailing Fin	CCSE-5, CCSE-18
26.	Head & Side Folding Nailing Fin	CCSE-5, CCSE-18
28.	Frame Lift Block	CCSE-5, CCSE-16
30.	Glass	CCSE-3, CCSE-19, CCSE-20, 21, CCSE-25, 26, 27
29.	Sash Tall Bulb Weatherstrip	CCSE-17
31.	Screen	Frame, CCSE-5, CCSE-23, CCSE-24
32.	Glazing Bead	Sash, CCSE-3, CCSE-22
33.	Complete Sash	Operating / Stationary CCSE-3, CCSE-4 CCSE-19, 20, 21

Parts Not Shown on Exploded View:

- Hinge Clip ————— Sash, CCSE-10
- DLX Keeper Locator ————— CCSE-11
- Construction "T" Handle ————— CCSE-12
- Truth Handles used on DLX and Prior ————— CCSE-13
- Casement Hardware DLX 2/2/98 to 9/19/05 ————— CCSE-13
- Casement Hardware (1988 - 2/2/1998) Split Arm Operator ————— CCSE-14
- Handed Sash Lock and Keepers ————— CCSE-14
- Casement Operator Prior to 1988 ————— CCSE-15
- Sash Alignment Snubber ————— CCSE-15
- Anti Bow Clip ————— CCSE-15
- Sash Limit Device ————— CCSE-16
- Structural Nail Fin ————— CCSE-16
- Weatherstrip ————— CCSE-17
- 2 Piece Surround Replacement Parts ————— CCSE-17

Sash Exploded View & Details

SASH AS VIEWED FROM THE INTERIOR

Important: When ordering Unit is Viewed from the EXTERIOR.

Item	Page
9.	CCSE-10
13.	CCSE-12, 14
15.	CCSE-12
18.	CCSE-11
19.	CCSE-11
20.	CCSE-10
22.	CCSE-16
29.	CCSE-16
30.	CCSE-26
32.	CCSE-22

See Page CCSE-2 for Complete Parts List.

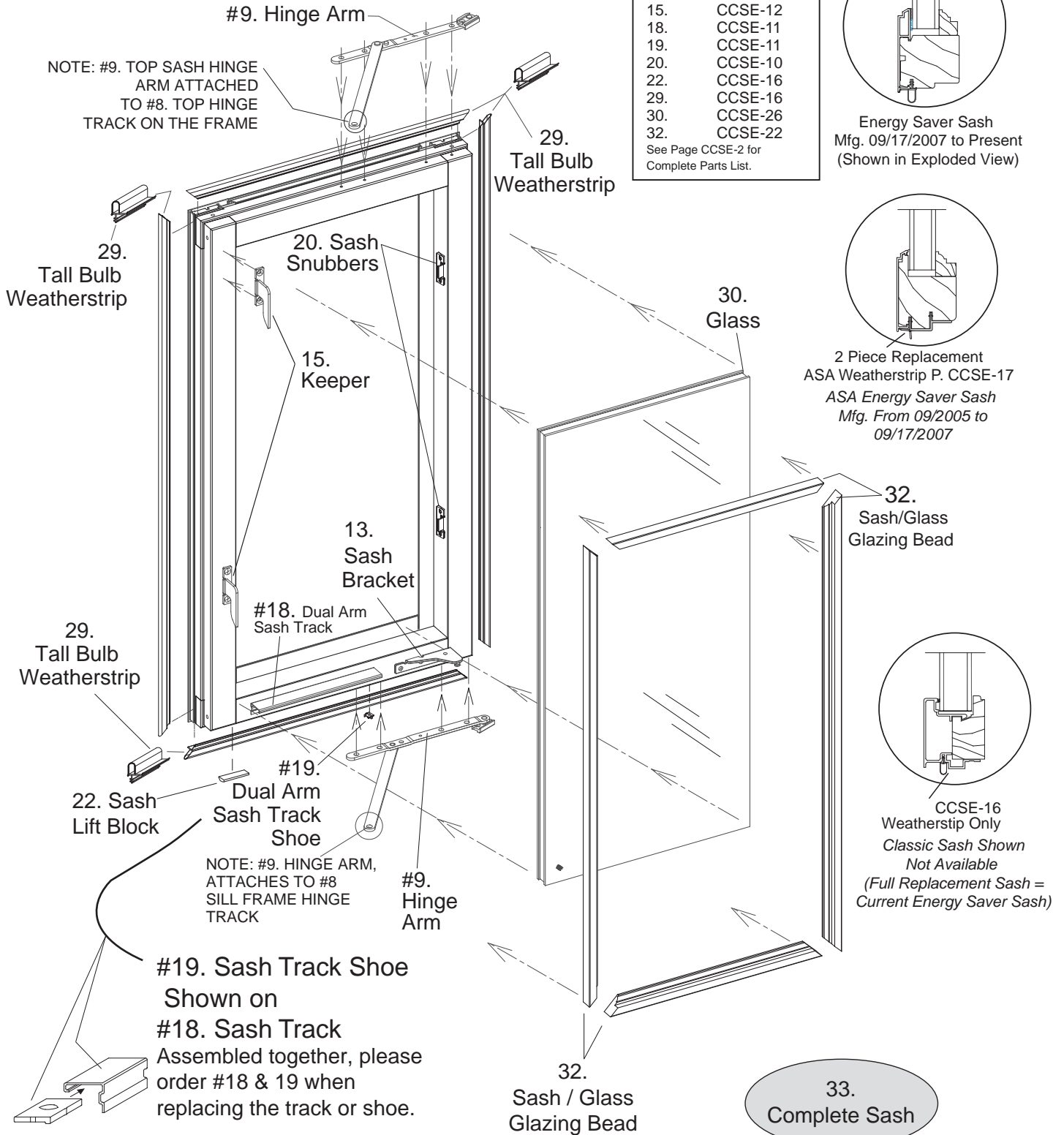

See Page CCSE-4, CCSE-19

Clad Wood Casement Windows Replacement Parts



09-17-2007 TO PRESENT

Operating Sash Elevation View & Details

CLAD CASEMENT OPERATING SASH ASSEMBLY AND DETAILS
SASH AS VIEWED FROM EXTERIOR

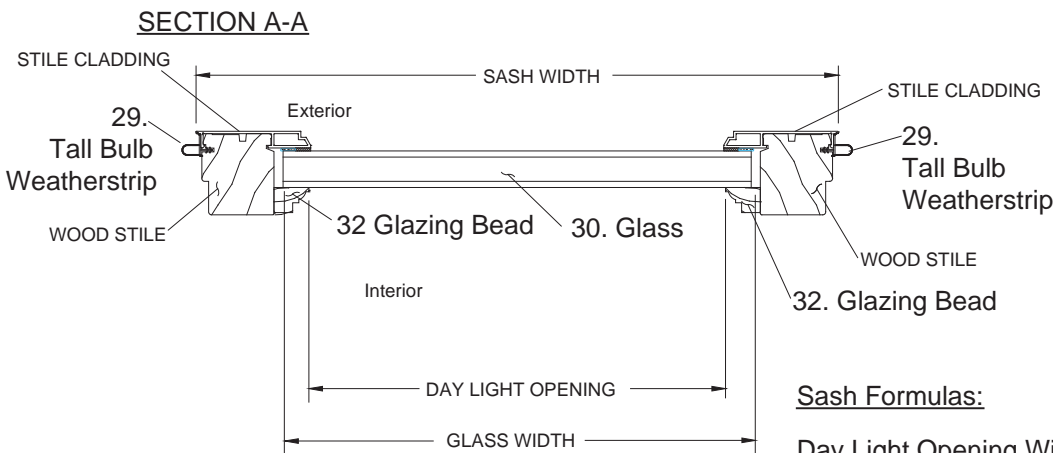
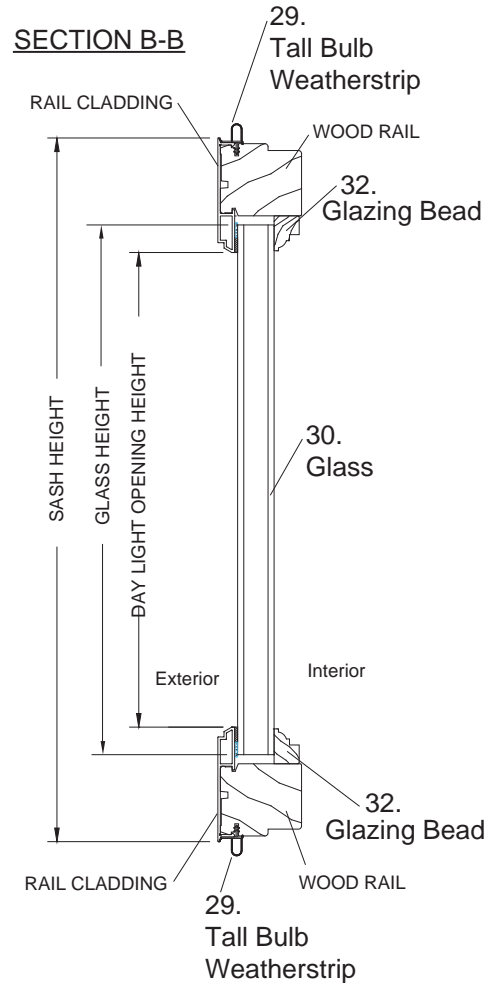
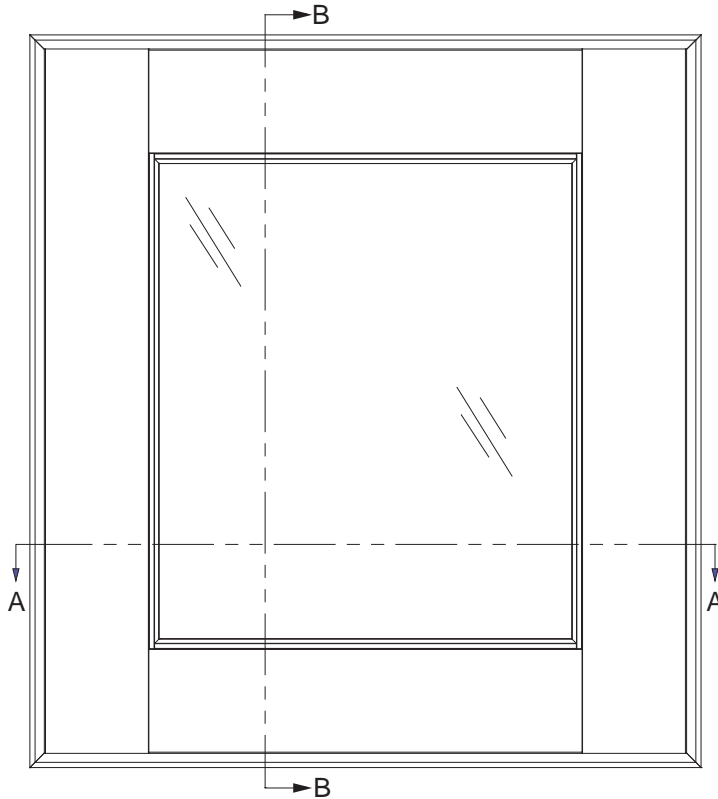

Item	Page
29.	CCSE-17
30.	CCSE-26
32.	CCSE-22

See Page CCSE-2 for Complete Parts List of Items.

Sash Formulas:

Day Light Opening Width = Glass Width - .875"
 Glass Width = Daylight Opening + .875"
 Sash Width = Glass + 3.625"
 Sash Width = Basic Unit Width - 1.5625"

Day Light Opening Height = Glass - .875"
 Glass Height = Day Light Opening Height + .875"
 Sash Height = Glass + 3.625"
 Sash Height = Basic Unit Height - 1.5625"

Clad Wood Casement Windows Replacement Parts

Frame Exploded View, Left Hand Unit Shown

SASH AS VIEWED FROM THE INTERIOR

Important: When ordering, Unit is Viewed from the EXTERIOR looking in.

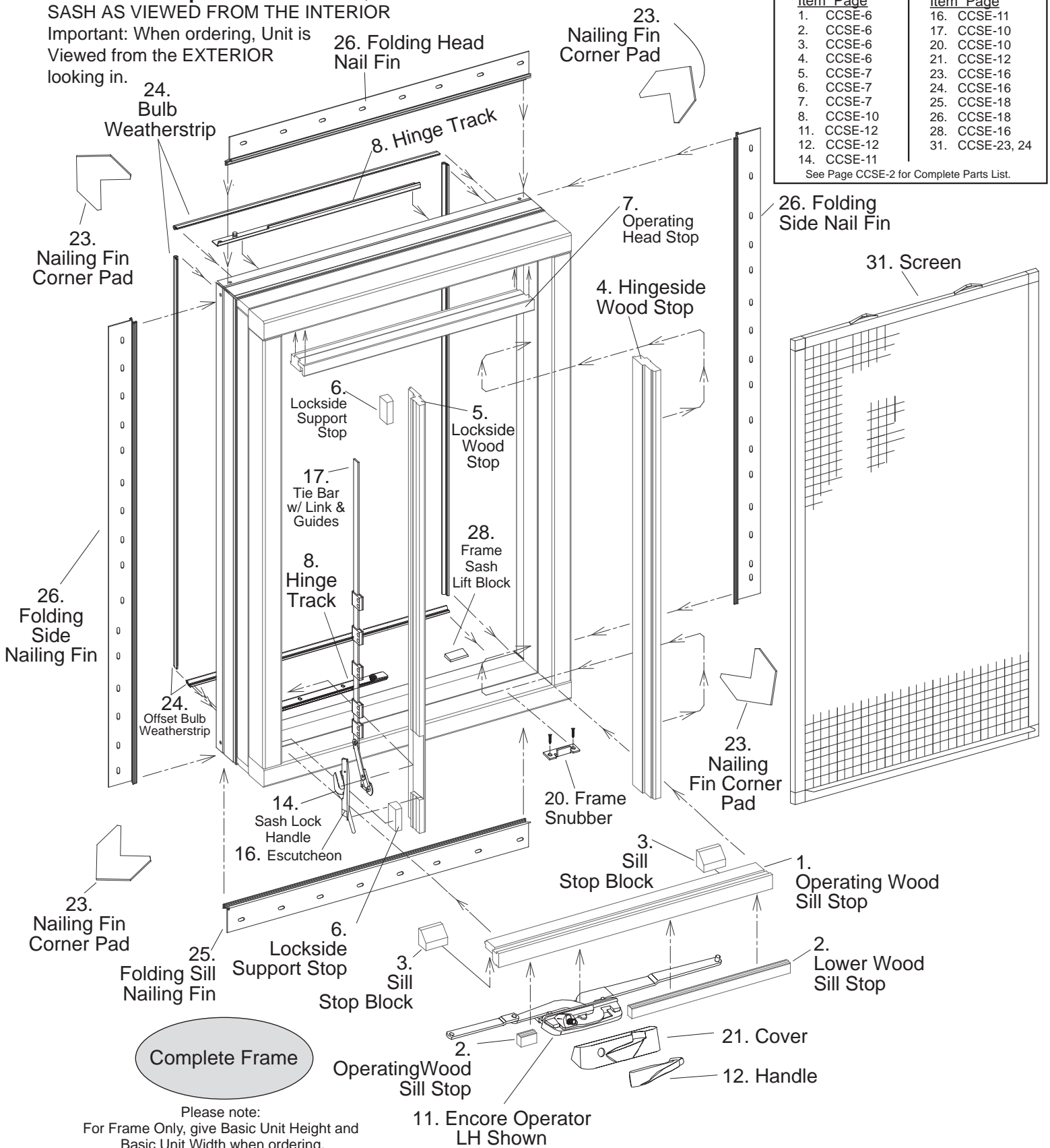

Clad Wood Casement Windows Replacement Parts



Wood Stops

Item 1

Operating Sill Stop (Upper Section)	Part No.
11 CCSE Sill Upper Section	213365
15 CCSE Sill Upper Section	213366
19 CCSE Sill Upper Section	213367
23 CCSE Sill Upper Section	213368
27 CCSE Sill Upper Section	213369
31 CCSE Sill Upper Section	213370
L/F	215851

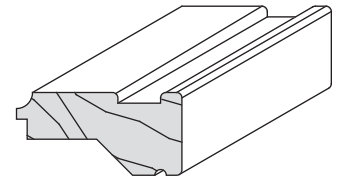

Item 2 (Encore & DLX)

Operating Sill Stop (Lower Section) Lockside and Hingeside Sill Stop required when ordering.	Part No.
11 CCSE Lower Sill Stop - Lockside	213372
15 CCSE Lower Sill Stop - Lockside	213373
19 CCSE Lower Sill Stop - Lockside	213374
23 CCSE Lower Sill Stop - Lockside	213375
27 CCSE Lower Sill Stop - Lockside	213376
31 CCSE Lower Sill Stop - Lockside	213377
11, 15, 19, 23, 27, 31 CCSE Lower Sill Stop - Hingeside	213371

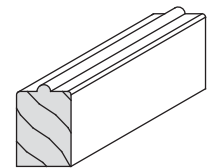

Split Arm Operating Sill Stop (2 Pcs. Required)	Part No.
CCSE Split Arm Lower Section (35-1/2" piece) (11" - 27" widths require field modification.)	204207

Item 3

Sill Stop Block (2 Pcs. / Operating Unit)	Part No.
CCSE Sill Stop Block, each	207608
CCSE Sill Stop Block, per lineal foot	207291

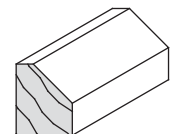

Item 4 (Encore & DLX)

Operating Hingeside Stop For Tie Bar Style Units	Part No.
19 CCSE Hingeside Stop	213325
23 CCSE Hingeside Stop	213326
27 CCSE Hingeside Stop	213327
31 CCSE Hingeside Stop	213328
35 CCSE Hingeside Stop	213329
43 CCSE Hingeside Stop	213330
47 CCSE Hingeside Stop	213331
55 CCSE Hingeside Stop	213332
59 CCSE Hingeside Stop	213333
67 CCSE Hingeside Stop	213334
L/F	215850

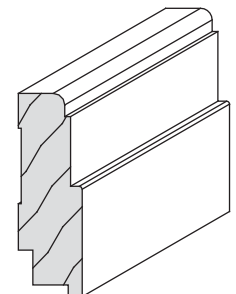

Note: Parts drawings not to scale.

 Tech Tip: Can also be used for Split Arm Lockside Stops with field modification.

Wood Stops

Item 5 (Encore & DLX)

Operating Lockside Stops (LH and RH Units)
For Tie Bar Style Units

Part No.
Left Right

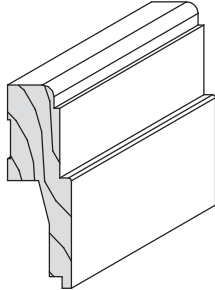

Right Shown

19 CCSE Lockside Stop	213305	213315
23 CCSE Lockside Stop	213306	213316
27 CCSE Lockside Stop	213307	213317
31 CCSE Lockside Stop	213308	213318
35 CCSE Lockside Stop	213309	213319
43 CCSE Lockside Stop	213310	213320
47 CCSE Lockside Stop	213311	213321
55 CCSE Lockside Stop	213312	213322
59 CCSE Lockside Stop	213313	213323
67 CCSE Lockside Stop	213314	213324
L/F	215849	

Item 6

Operating Lockside Support Block

Part No.

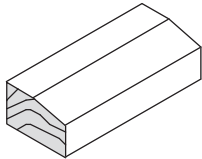

CCSE Support Block, each	207910
CCSE Lockside Support Block, per lineal foot	207778

Item 7

Operating Head Stop
For Lift Rail Style Screen only

Part No.

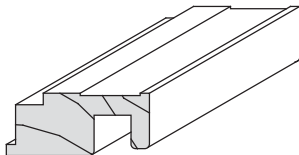

11 CCSE Operating Head Stop	213335
15 CCSE Operating Head Stop	213336
19 CCSE Operating Head Stop	213337
23 CCSE Operating Head Stop	213338
27 CCSE Operating Head Stop	213339
31 CCSE Operating Head Stop	213340
L/F	215852



Tech Tip: Head Stop for Plunger Style Screen not available. Lift Rail Screens offered after 2/2/98.

Note: Parts drawings not to scale.

Clad Wood Casement Windows Replacement Parts



Wood Stops

A. Stationary Head and Sill Stop (2 Pcs. / unit required) Part No.

11 CCSE Stationary Head and Sill Stop	213341
15 CCSE Stationary Head and Sill Stop	213342
19 CCSE Stationary Head and Sill Stop	213343
23 CCSE Stationary Head and Sill Stop	213344
27 CCSE Stationary Head and Sill Stop	213345
31 CCSE Stationary Head and Sill Stop	213346
35 CCSE Stationary Head and Sill Stop	213347
43 CCSE Stationary Head and Sill Stop	213348
47 CCSE Stationary Head and Sill Stop	213349
55 CCSE Stationary Head and Sill Stop	213350
59 CCSE Stationary Head and Sill Stop	213351
67 CCSE Stationary Head and Sill Stop	213352
L/F	215866

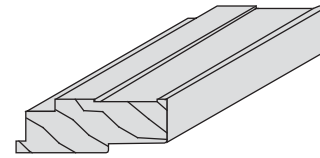

B. Stationary Side Stop (2 Pcs. / unit required) Part No.

11 CCSE Stationary Side Stop	213353
15 CCSE Stationary Side Stop	213354
19 CCSE Stationary Side Stop	213355
23 CCSE Stationary Side Stop	213356
27 CCSE Stationary Side Stop	213357
31 CCSE Stationary Side Stop	213358
35 CCSE Stationary Side Stop	213359
43 CCSE Stationary Side Stop	213360
47 CCSE Stationary Side Stop	213361
55 CCSE Stationary Side Stop	213362
59 CCSE Stationary Side Stop	213363
67 CCSE Stationary Side Stop	213364
L/F	215866

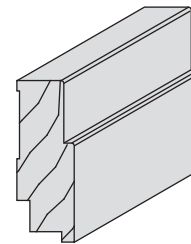

Note: Parts drawings not to scale.

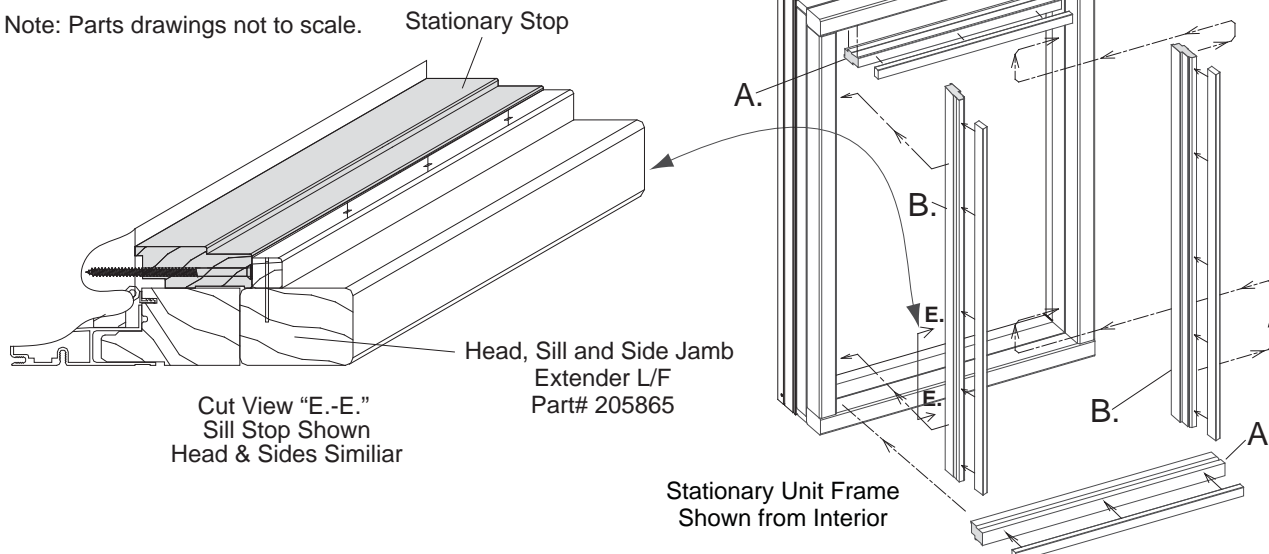

Wood Stops

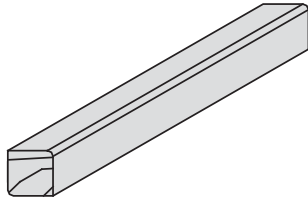

C. Head and Sill Stationary Screw Covers

Part No.

11 CCSE Head and Sill Stationary Screw Covers	216079
15 CCSE Head and Sill Stationary Screw Covers	216080
19 CCSE Head and Sill Stationary Screw Covers	216081
23 CCSE Head and Sill Stationary Screw Covers	216082
27 CCSE Head and Sill Stationary Screw Covers	216083
31 CCSE Head and Sill Stationary Screw Covers	216084
35 CCSE Head and Sill Stationary Screw Covers	216085
43 CCSE Head and Sill Stationary Screw Covers	216086
47 CCSE Head and Sill Stationary Screw Covers	216087
55 CCSE Head and Sill Stationary Screw Covers	216088
59 CCSE Head and Sill Stationary Screw Covers	216089
67 CCSE Head and Sill Stationary Screw Covers	216090
L/F	216115

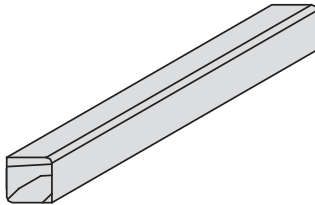

D. Side Stationary Screw Cover

Part No.

11 CCSE Side Stationary Screw Covers	216067
15 CCSE Side Stationary Screw Covers	216068
19 CCSE Side Stationary Screw Covers	216069
23 CCSE Side Stationary Screw Covers	216070
27 CCSE Side Stationary Screw Covers	216071
31 CCSE Side Stationary Screw Covers	216072
35 CCSE Side Stationary Screw Covers	216073
43 CCSE Side Stationary Screw Covers	216074
47 CCSE Side Stationary Screw Covers	216075
55 CCSE Side Stationary Screw Covers	216076
59 CCSE Side Stationary Screw Covers	216077
67 CCSE Side Stationary Screw Covers	216078
L/F	216115

Note: Parts drawings not to scale.



Tech Tip: Began using screw covers August, 2005.

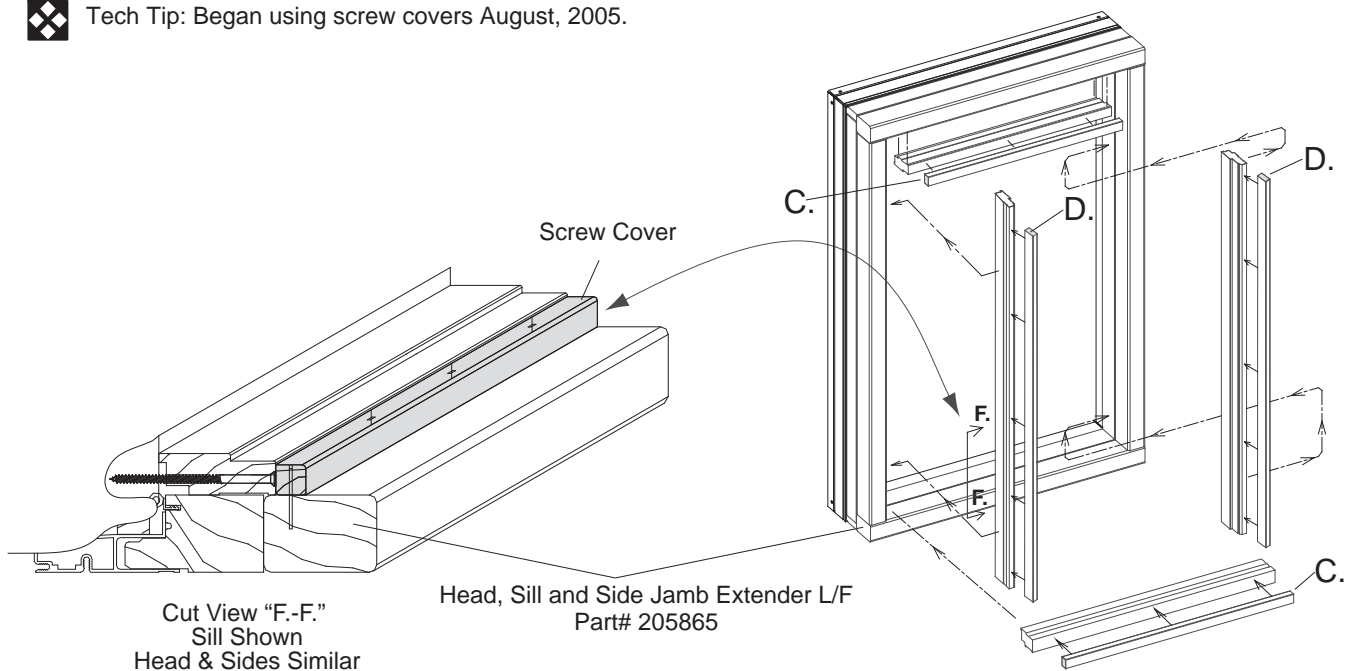

Clad Wood Casement Windows Replacement Parts



Items 8 - 20

Hardware / Miscellaneous

Frame & Sash Hardware

(Applicable to Encore, DLX, Split Arm as noted Feb 1998 to Present)

Item No.	Description	Egard, Standard		Stainless Steel, Optional	
		Left	Right	Left	Right
17					
19	Tie Bar w/Guides - Encore & DLX	097820	097821	093958	093959
23	Tie Bar w/Guides - Encore & DLX	097822	097823	096156	096155
27	Tie Bar w/Guides - Encore & DLX	097804	097805	093938	093939
31	Tie Bar w/Guides - Encore & DLX	097806	097807	093940	093941
35	Tie Bar w/Guides - Encore & DLX	097808	097809	093942	093943
43	Tie Bar w/Guides - Encore & DLX	097810	097811	093944	093945
47	Tie Bar w/Guides - Encore & DLX	097812	097813	093946	093947
55	Tie Bar w/Guides - Encore & DLX	097814	097815	093948	093949
59	Tie Bar w/Guides - Encore & DLX	097816	097817	093950	093951
67	Tie Bar w/Guides - Encore & DLX	097818	097819	093952	093953
75	Tie Bar w/Guides - Encore & DLX	097827	097828	095430	095431
	Tie Bar Guide only		011790		

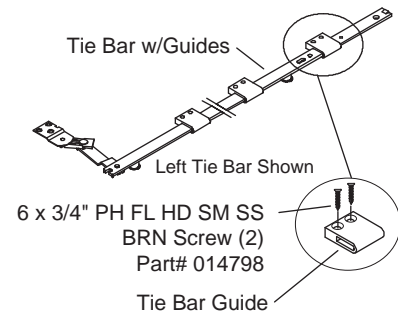

Tie Bar Guide Schedule

Unit Height	Tie Guides Required
11", 15"	1
23", 27", 35", 43", 47"	2
55", 59", 67"	3

Note: Fasteners are ordered separately.

20 **CCSE Stainless Steel Sash Snubber** _____ 010808

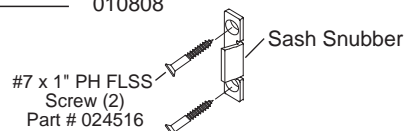

CCSE Frame Snubber _____ 093839

Snubber Schedule

43-47, 55 Unit Heights = 2 per unit
59 and 67 Unit Heights = 4 per unit

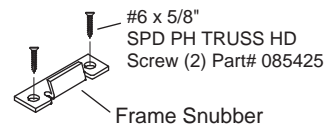

Not Shown on Exploded Views **CCSE Hinge Clip (23 Egress only)** _____ 019014

CCSE Hinge Clip (14") _____ 076005

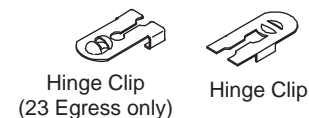

Note: Parts drawings not to scale.

Hardware / Miscellaneous

Note: Fasteners are ordered separately.

Items 14 - 28

Casement Hardware Encore and DLX

Note: Parts drawings not to scale.

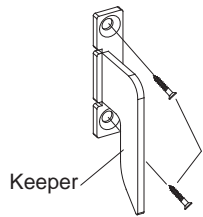

#8 x 1-1/4" PH FH HD SM
SS Screw (2)
Part # 017806

Lock Handle &
Escutcheon Shown
Assembled

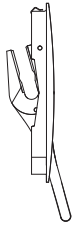

Part# 099028, Qty 2
per Lock Escutcheon,
Ordered Separately

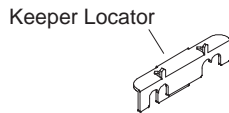
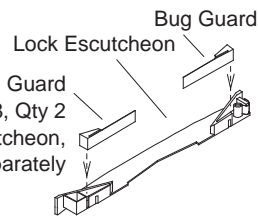

#7 x 7/8" PH FL HD SS
Screw (3) Part# 099285



Item No.	Description	Left	Part No.	Right
15	CCSE Keeper 27, 31 ,35 Unit Heights = 1 per unit 43 and 47 Unit Heights = 2 per unit 55, 59, 67 Units Heights = 3 per unit	096347		096348
14	CCSE Lever Lock Handle Gold Tone _____ White _____ Bronze _____ Bright Brass _____ Antique Brass _____ Oil-Rubbed Bronze _____ Coppertone _____ Champagne _____ Brushed Nickel _____ Brushed Chrome _____ Polished Chrome _____		096419 010265 090933 010263 096448 099808 096447 096497 096449 094570 096450	
16	CCSE Lock Escutcheon WITH Guard Gold Tone _____ White _____ Bronze _____ Bright Brass _____ Antique Brass _____ Oil-Rubbed Bronze _____ Coppertone _____ Champagne _____ Brushed Nickel _____ Brushed Chrome _____ Bright Chrome _____		099029 099030 099032 099031 099034 099810 099033 099038 099035 099037 099036	

CCSE Rustic Lock Lever Handle & Escutcheon w/Guards

Rustic - Light Bronze _____ 099620

Rustic - Dark Bronze _____ 099621

Part#'s include Lever Lock Handle & Escutcheon w/Guard

DLX Keeper Locator _____ 072014

18 **CCSE Dual Arm Sash Track** _____ 098498

19 **CCSE Dual Arm Sash Track Shoe** _____ 011789

Please note, # 18 & 19 is an assembly. Please order both parts when replacing the track or shoe.

Clad Wood Casement Windows Replacement Parts



Notes:

- Encore hardware is interchangeable with DLX units.
- Fasteners are ordered separately, See page 15 for a complete list and part numbers.

Hardware / Miscellaneous

Casement Hardware Encore (9/19/05 to Present)

Item No.	Description	Left	Part No.	Right
11	<u>CCSE Encore Dual Arm Operator</u>	096340		096341
11	<u>CCSE Encore Dyad Arm Operator (11, 15 width)</u> With E-Gard Finish	096338		096339
	<u>CCSE Encore Reverse Dyad</u> For small speciality windows. With E-Gard Finish	096655		096654
	<u>Construction "T" Handle</u> Sept. 2006 to Present		097103	
13	<u>CCSE Sash Bracket - Encore & DLX</u> For Dual Arm & Dyad Operator	096349		096350
	<u>CCSE Sash Bracket - Split Arm</u>	015198		015199
	<u>CCSE Bracket</u> Non-handad Reverse Dyad Operator Bracket		096656	

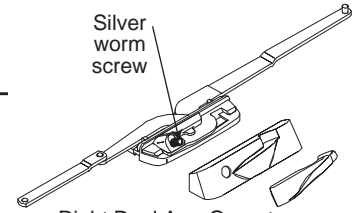

Right Dual Arm Operator with Right Operator Cover and Handle Package

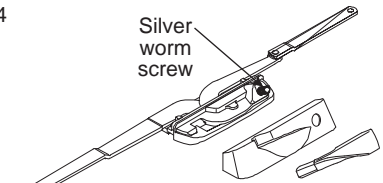

Left Dual Arm Operator with Left Operator Cover and handle Package

Left Dyad Operator with Right Operator Cover and Handle Package

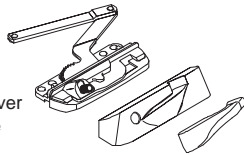

Right Dyad Operator with Left Operator Cover and Handle Package

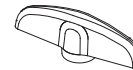
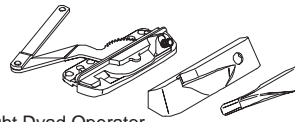

Not Shown on Exploded Views

12 & 21

<u>Encore Operator Cover and Handle Set Package</u>	
Gold Tone	096357
White	096353
Bronze	096355
Bright Brass	096363
Antique Brass	096660
Oil-Rubbed Bronze	099811
Coppertone	096657
Champagne	096374
Brushed Nickel	096667
Brushed Chrome	096361
Polished Chrome	096665

FOR:
Left Dual Arm Operator
or
Right Dyad Operator

FOR:
Right Dual Arm Operator
or
Left Dyad Operator

Right Operator Cover and Handle Package



Left Operator Cover and Handle Package Shown Assembled

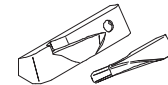

Left Operator Cover and Handle Package



Tech Tip: Encore cover and handles sold as sets only.

Note: When ordering replacement operators, note the configuration of left and right hand operators and their corresponding cover and handle packages. Take care that the correct cover and handle package is ordered with your operator.

	Left	Right
Rustic - Light Bronze	099616	099618
Rustic - Dark Bronze	099617	099619

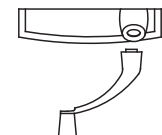

Note: Parts drawings not to scale.

Hardware / Miscellaneous

Casement Hardware

DLX 2/2/98 to 9/19/05

(Not Shown on Exploded Views)

Notes: Fasteners are ordered separately.

Item No.	Description	Part No.	
		Left	Right
Not Shown on Exploded Views	<u>CCSE Dual Arm Operator</u>		
	Gold Tone	010723	010722
	White	010724	010725
	Bronze	090937	090938
	Bright Brass	010726	010727
	Oil-Rubbed Bronze	095415	095416
	Brushed Chrome	095422	095423
	<u>CCSE Dyad Arm Operator (11, 15 widths)</u>		
	Gold Tone	010731	010732
	White	010733	010734
	Bronze	090935	090936
	Bright Brass	010735	010736
	Oil-Rubbed Bronze	095417	095418
	Brushed Chrome	095424	095425

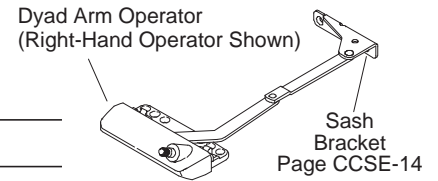
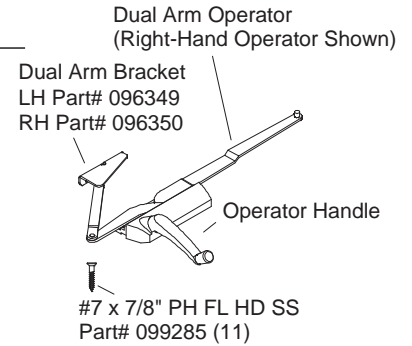

Handles used on DLX & Prior

Not Shown on Exploded Views	<u>CCSE Truth Operator Crank Handle</u>	
	Gold Tone	010768
	White	010769
	Bronze	090934
	Bright Brass	031951
	Oil-Rubbed Bronze	095420
	Brushed Chrome	095427

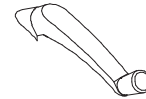

Not Shown on Exploded Views	<u>CCSE Folding Operator Handle</u>	
	Gold Tone	037188
	White	037189
	Bronze	091691
	Bright Brass	030165
	Oil-Rubbed Bronze	094564
	Brushed Chrome	094569

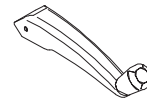

Not Shown on Exploded Views	<u>Operator "T" Crank Handle</u>	
	Gold Tone	019915
	White	021951
	Bronze	092684
	Bright Brass	031962



Not Shown on Exploded Views	<u>Operator Hand Knob</u>	
	Gold Tone	021949
	White	021950
	Bronze	092427
	Bright Brass	031961

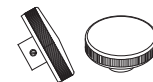

Not Shown on Exploded Views	<u>Operator Nesting Cover</u>	<u>LH Dyad RH</u>	<u>RH Dyad LH</u>
	Gold Tone	095355	095356
	White	095237	095238
	Bronze	095239	095240
	Oil-Rubbed Bronze	094563	094562
	Brushed Chrome	094568	094567

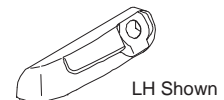

(Matched Handing except 11 & 15 which Use Opposite)

For use with DLX hardware only. Use with Folding Operator handle.

Note: Parts drawings not to scale.

Clad Wood Casement Windows Replacement Parts



Hardware / Miscellaneous

Note: Fasteners are ordered separately.

Please Note: Hardware on this page are available as supplies last.
If part is unavailable please use kits that are listed on page CCSE-15

Casement Hardware (All Prior to 2/2/98)

Split Arm Operator

Item No.	Description	Part No.	
		Left	Right
Not Shown on Exploded Views	CCSE 10" Adjustable Hinge Track	092994	092995
	CCSE Hinge Arm (11, 15, 19, 23, 27)	096331	096332
	CCSE Hinge Clip		019014

 Tech Tip: Same as Encore/DLX 23" Egress parts.

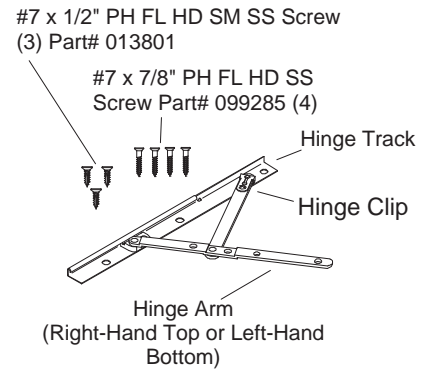

No longer available.

Not Shown on Exploded Views	CCSE Split Arm Operator - Gold Tone	045196	045197
	CCSE Split Arm Operator - White	018909	018910

Note: All handles used on DLX and prior can be used on split arm ~~except~~ nesting cover. See page CCSE-13.

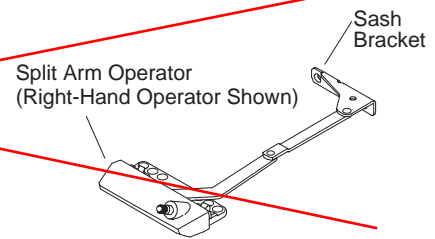

13	CCSE Sash Bracket	015198	015199
-----------	--------------------------	--------	--------



Not Shown on Exploded Views	CCSE Handed Sash Lock		
	Gold Tone	N/A	N/A
	White	N/A	N/A

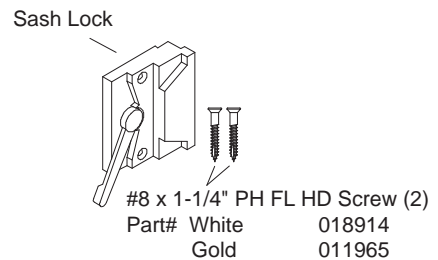

Not Shown on Exploded Views	CCSE Keeper- E-gard	N/A	
-----------------------------	----------------------------	-----	--

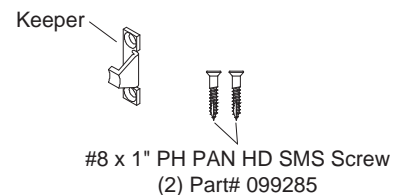

Note: Parts drawings not to scale.

Hardware / Miscellaneous

Casement Operator

Prior to 1988, Please go to truth.com for local dealer to order replacement parts.

No longer
available from
Hurd.



Left Hand Shown

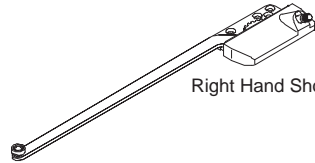

Right Hand Shown

Item No.	Description	Left	Part No.	Right
Not Shown on Exploded Views	CCSE Short Arm Operator - Gold (9-1/2" Straight Arm) 11, 15 Glass Widths	010497		010502
	CCSE Short Arm Operator - White (7-1/2" Straight Arm) 11, 15 Glass Widths	035894		035895
	CCSE Long Arm Operator - Gold (13-1/2" Straight Arm) 19, 23, 27, 31 Glass Widths	040529		040530
	CCSE Long Arm Operator - White (13-1/2" Straight Arm) 19, 23, 27, 31 Glass Widths	035892		035893
	ARCH CCSE Single Arm Operator - Gold (7-1/2" Straight Arm) 11, 15 Glass Widths	035890		035891

No longer
available from
Hurd.

❖ TechTip: Split Arm Locks and Keepers and 23" Egress hinges will work with this hardware. Stops are not available.

Not Shown on Exploded Views	CCSE Sash Alignment Snubber	098848
-----------------------------------	------------------------------------	--------

	CCSE Anti Bow Clip	098849
--	---------------------------	--------

❖ Tech Tip: Sash Alignment Snubber and Anit Bow Clip are for Field adjustments only.

Arm/Track Kits

Hardware - All Product for All Production Dates

(This is a snap-on style arm/track system)

	Description	Part No.
Used for all production dates on Clad and All-Wood products	CCSE 10" Egress Stainless Steel Hinge Arm/Track Kit (11", 15" and 23" unit widths) Includes: 10" S.S. Egress Left Hinge #098493, 10" S.S. Egress Right Hinge #098494 10" S.S. Egress Left Hinge Track #098487, 10" S.S. Egress Right Hinge Track #098488	096995
Clad products produced from 1998 to Present All-Wood products produced from 1998 to April 2004 and All-Wood standard product from May 2004 to present	CCSE 14" Egress Stainless Steel Hinge Arm/Track Kit (19" unit widths and taller) Includes: 14" S.S. Egress Left Hinge #098483, 14" S.S. Egress Right Hinge #098484 14" S.S. Egress Left Hinge Track #098481, 14" S.S. Egress Right Hinge Track #098482	096996
Used for all production dates on Clad and All-Wood products	CCSE 10" Egress Egard Hinge Arm/Track Kit (11", 15" and 23" unit widths) Includes: 10" Egress Left Hinge #098496, 10" Egress Right Hinge #098495 10" Egress Left Hinge Track #098487, 10" Egress Right Hinge Track #098488	096998
Clad products produced from 1998 to Present All-Wood products produced from 1998 to April 2004 and All-Wood standard product from May 2004 to present	CCSE 14" Egress Egard Hinge Arm/Track Kit (19" unit widths and taller) Includes: 14" Egress Left Hinge #098485, 14" Egress Right Hinge #098486 14" Egress Left Hinge Track #098481, 14" Egress Right Hinge Track #098482	096997

Clad Wood Casement Windows Replacement Parts



Hardware / Miscellaneous

Items 23 - 27 Weatherstripping / Miscellaneous

Item No.	Description	Where Used	Part No.
24	Frame Offset Bulb Weatherstrip Head, Sill and Sides Applicable for all models.		020546
<i>For DLX, Split Arm & Straight Arm Classic Sash only</i>			
	Large Bulb Weatherstrip		White Brown Sand
	From 09/17/07 to Present		011814 015200 015582

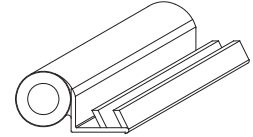

Not Shown
on Exploded
Views

CCSE Sash Limit Device

See last page in catalog for Limit Device Application
Limit device allows sash to open a maximum of 4".

- Limit Stop Arm ————— 096370
- Limit Bracket with Stud ——— 096372
- Limit Track ————— 096373
- Complete Set ————— 025857

#6 x 5/8" PH PAN
HD SM Screw (2)
Part# 085425

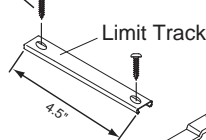

6 x 3/4" PH
PAN HD SM
Screw Part# 014798 (4)

Limit Stop Arm Bracket w/ Stud

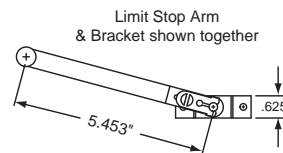

Tech Tip: Required on 2767, 3159 and 3167. Available as an accessory for other sizes.

Aluminum Structural Nail Fin ————— Head, Sill and Sides of Frame.
Applicable for all models.

12'-0" L/F White Painted, pre-fab ————— 095921
With Pre-punched Holes

20'-0" L/F - White Painted, ————— 097130
NO Pre-Punched Holes

Use #6 x 1/2" Self Drilling PH PANHD SM Steel ————— 010777
Screw to apply Nail Fin 2" from Each Corner and
8-10" On Center Thereafter.

Use SM 5731 Silicone to attach Nail Fin ————— 024262

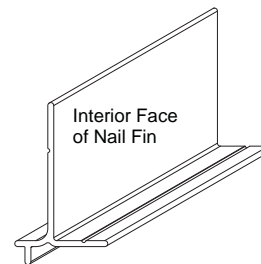

22 Sash Lift Block - Beige

Bottom of sash.
For Encore and DLX

011823

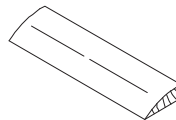

28 Frame Lift Block - Clear

Top of Aluminum Sill.
For Encore and DLX

095235

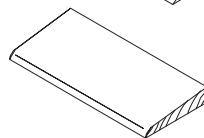

"C" Hinge Shim

Service item - installed between bottom hinge
and sash or bottom track and frame.

Service Item

015511

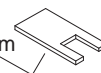

23 Nailing Fin Corner Pad Set of Four

For all frames using nailing fin.

015186



Note: Parts drawings not to scale.

Hardware / Miscellaneous

Items 34 - 39

Weatherstripping / Miscellaneous

Item No.	Description	Where Used	Part No.		
See Page CCSE-3 Cross Section Views					
For Encore & DLX Energy Saver Sash 9/19/05 to 9/17/2007 (see below)					
			<u>White</u>	<u>Brown</u>	<u>Sand</u>
11	CCSE Energy Saver Surround End Cap		099525	099549	099537
15	CCSE Energy Saver Surround End Cap		099526	099550	099538
19	CCSE Energy Saver Surround End Cap		099527	099551	099539
23	CCSE Energy Saver Surround End Cap		099528	099552	099540
27	CCSE Energy Saver Surround End Cap		099529	099553	099541
31	CCSE Energy Saver Surround End Cap		099530	099554	099542
35	CCSE Energy Saver Surround End Cap		099531	099555	099543
43	CCSE Energy Saver Surround End Cap		099532	099556	099544
47	CCSE Energy Saver Surround End Cap		099533	099557	099545
55	CCSE Energy Saver Surround End Cap		099534	099558	099546
59	CCSE Energy Saver Surround End Cap		099535	099559	099547
67	CCSE Energy Saver Surround End Cap		099536	099560	099548
L/F			099522	099524	099523

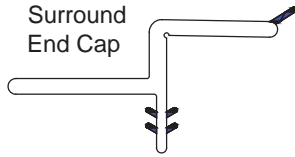

2 Piece Surround Field Replacement Parts

Note:
Please order *surround end cap* & *bulb weatherstrip* as separate parts.

Energy Saver Sash 09/19/05 to 09/17/2007 Shown

Install 1st #29 Sash Weatherstrip

Install 2nd Surround End Cap

Shown Installed

Reference:

For Encore & DLX Energy Saver Sash purchased from 08/2/04 to 09/17/2007

Replace with Energy Saver Surround End Cap Use 2 Piece Surround Field Replacement parts.

Note: Part's include both Surround End Cap & Sash Weatherstrip

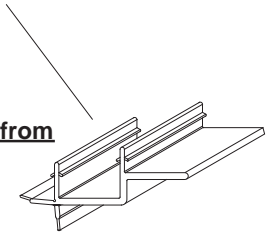

For Encore & DLX Energy Saver Sash purchased from 08/19/02 to 08/2/2004

Replace with Weatherstrip #29 for replacement

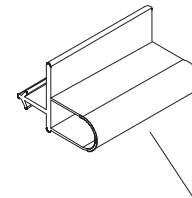

For Encore & DLX Energy Saver Sash 08/19/02 to 08/2/2004 (see above) & Sash Mfg. From 09/17/2007 to Present

#29 Sash Tall Bulb Weatherstrip From 09/17/07 to Present For Sash: Head, Side & Sill

	<u>White</u>	<u>Brown</u>	<u>Sand</u>
11 CCSE	098763	098787	098775
15 CCSE	098764	098788	098776
19 CCSE	098765	098789	098777
23 CCSE	098766	098790	098778
27 CCSE	098767	098791	098779
31 CCSE	098768	098792	098780
35 CCSE	098769	098793	098781
43 CCSE	098770	098794	098782
47 CCSE	098771	098795	098783
55 CCSE	098772	098796	098784
59 CCSE	098773	098797	098785
67 CCSE	098774	098798	098786
L/F	098760	098761	098762

L/F 1/16" x 5/16" CCSE Acrylic Black Tape — 098836

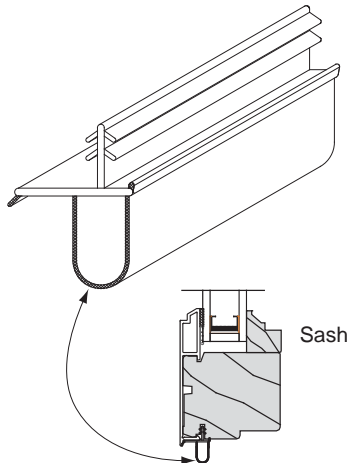

**Sash Mfg. From 07/17/2007 to Present
Shown Uses Sash Bulb Only**

Note: Parts drawings not to scale.

Clad Wood Casement Windows Replacement Parts



Hardware / Miscellaneous

Items 25 - 26

Vinyl Nail Fin

Item No.	Description	Part No.
25	<u>Sill Vinyl Folding Nailing Fin</u>	
11 CCSE		037181
15 CCSE		029002
19 CCSE		029003
23 CCSE		029004
27 CCSE		029005
31 CCSE		029006
35 CCSE		029007
43 CCSE		029008
47 CCSE		029009
55 CCSE		029010
59 CCSE		029011
67 CCSE		029012
11-2 CCSE		037182
15-2 CCSE		029013
19-2 CCSE		029014
23-2 CCSE		029015
27-2 CCSE		029016
11-3 CCSE		037184
15-3 CCSE		029017
19-3 CCSE		029018
23-3 CCSE		029019
27-3 CCSE		029020
L/F _____		024195

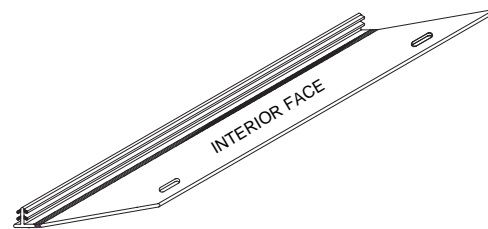
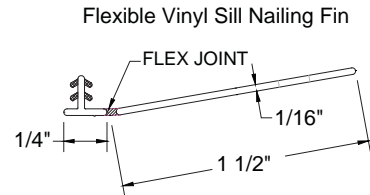

26

Head & Side Vinyl Nailing Fin

11 CCSE		037179
15 CCSE		028983
19 CCSE		028984
23 CCSE		028985
27 CCSE		028986
31 CCSE		028987
35 CCSE		028988
43 CCSE		028989
47 CCSE		028990
55 CCSE		028991
59 CCSE		028992
67 CCSE		028993
11-2 CCSE		037180
15-2 CCSE		028994
19-2 CCSE		028995
23-2 CCSE		028996
27-2 CCSE		028997
11-3 CCSE		037185
15-3 CCSE		028998
19-3 CCSE		028999
23-3 CCSE		029000
27-3 CCSE		029001
L/F _____		024194

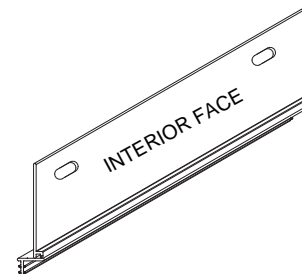
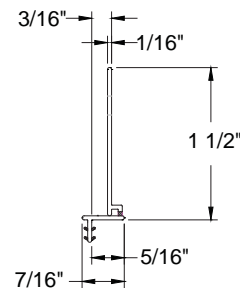

Note: Parts drawings not to scale.

Sash Assembly

Sash will be shipped as common air product, unless specified differently. No part numbers are needed to order. Common air means that the space between the glass is always the same. Glass thicknesses change depending on the size and specifics about the glass to be installed in to the frame. Normally glass up to 12.9 square feet will have an over all glass depth of 3/4". Glass from 13 square feet to 19.9 square feet will have an over all glass depth of 13/16". Glass from 20 square feet to 36 square feet will have an over all glass depth of 61/64". Tempering or specialty glass will change the depth of the over all glass unit.

When ordering Replacement Sash Assembly for Stationary or Operating Windows please include the following information:

- **EXTERIOR:** Clad Color _____
- **PRODUCT TYPE:** Glass depth or specify what type of interior glazing bead is on the outside _____
- **GLASS TYPE REQUESTED:** Single Strength, Low-E, Climate Control or Super Sunblocker, etc.
Note: If special glass is needed (tinted, GIAS, obscure, tempered or CHDL) please be specific. _____
- **GLASS SIZE:** See Page CCSE-4 & CCSE-20 For Formulas (ACTUAL OR DAYLIGHT OPENING):
State which dimension is specified; width first, then height. _____
- **GLASS DEPTH:** 1" or 3/4" _____
- **HINGING:** State if Operating Left or Right or Stationary _____
- **GLASS IDENTIFICATION CODE / YEAR OF MANUFACTURE:** _____
Note: Glass codes can be found on the bottom left hand corner of the glass as viewed from the interior of your sash, see Illustrations below.
- **TYPE OF OPERATOR STYLE:** (Encore; DLX; Split Arm or Straight Arm etc.) _____

Note: Custom color sash and specialty glass prices are available through HURD Quote Department.

Operating Sash Glass Sizes

11x11	19x11	27x11
11x15	19x15	27x15
11x19	19x19	27x19
11x23	19x23	27x23
11x27	19x27	27x27
11x31	19x31	27x31
11x35	19x35	27x35
11x43	19x43	27x43
11x47	19x47	27x47
11x55	19x55	27x55
11x59*	19x59	27x59
11x67*	19x67	27x67
15x11	23x11	31x11
15x15	23x15	31x15
15x19	23x19	31x19
15x23	23x23	31x23
15x27	23x27	31x27
15x31	23x31	31x31
15x35	23x35	31x35
15x43	23x43	31x43
15x47	23x47	31x47
15x55	23x55	31x55
15x59	23x59	31x59
15x67	23x67	31x67*

*Glass must be tempered.

Stationary Sash Glass Sizes
can be Found on CCSE-21

All Sash Glass Codes I.D.

Identification Code Effective October 1, 1998 - June 1, 2002.
This will be stamped in black ink on the spacer bar that separates the glass as shown in Illustration #1.

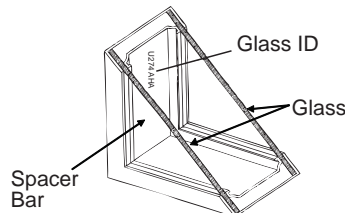

Illustration #1

Please see separate "Hurd Glass Code Identification Document" provided by your Distributor, for a complete list of definitions of your glass identification codes.

Identification Code Effective June 1, 2002 to Present
Will be laser etched on the # 3 surface of the glass.
With exception of non-rectangular shapes, that will be etched on the spacer bar as shown Illustration #2.

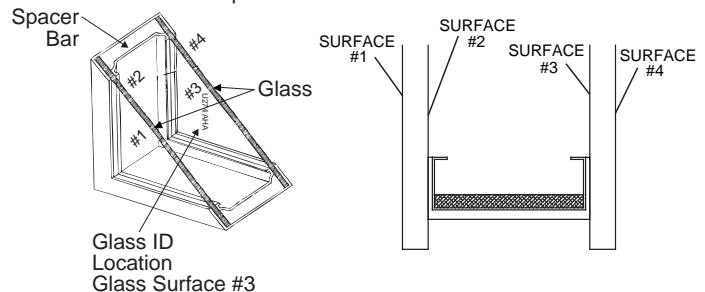

Illustration #2

Clad Wood Casement Windows Replacement Parts



Stationary Picture Sash N' Frame Section Details

Stationary Picture Sash Formulas:

Day Light Opening Width = Basic Unit Width - 6.2484"
 Day Light Opening Width = Glass - .875"
 Glass Width = Basic Unit Width - 5.188"
 Sash Width = Basic Unit Width - 1.5625"
 Sash Width = Glass + 3.625"

Day Light Opening Height = Basic Unit Height - 6.2484"
 Day Light Opening Height = Glass Height - .875"
 Glass Height = Basic Unit Height - 5.188"
 Sash Height = Basic Unit Height - 1.5625"
 Sash Height = Glass Height + 3.625"

Please note:

For Ordering Frame Only, Please provide Basic Unit Height & Basic Unit Width OR Glass Height & Glass Width when ordering.

Item	Page
30.	CCSE-27
32.	CCSE-22

See Page CCSE-2 for Complete Parts List of Items.

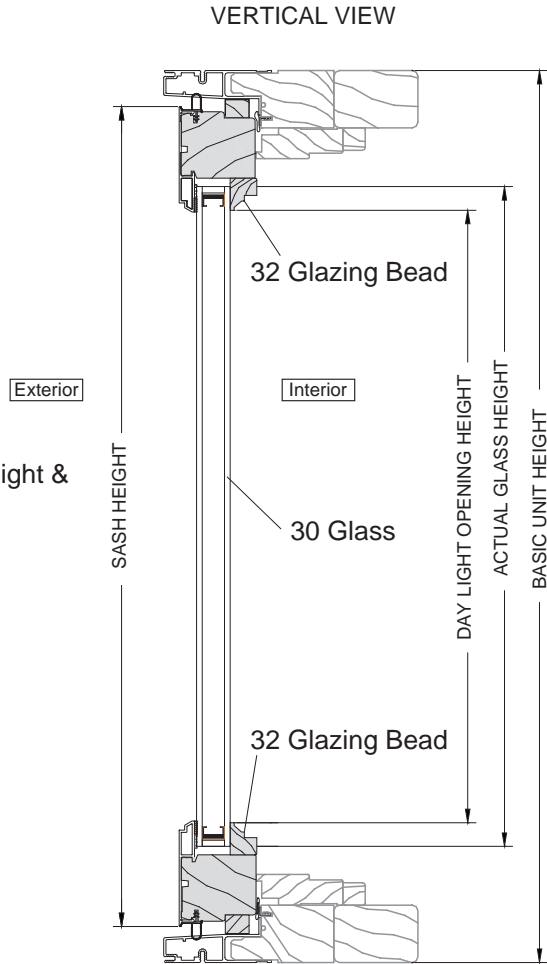

HORIZONTAL VIEW

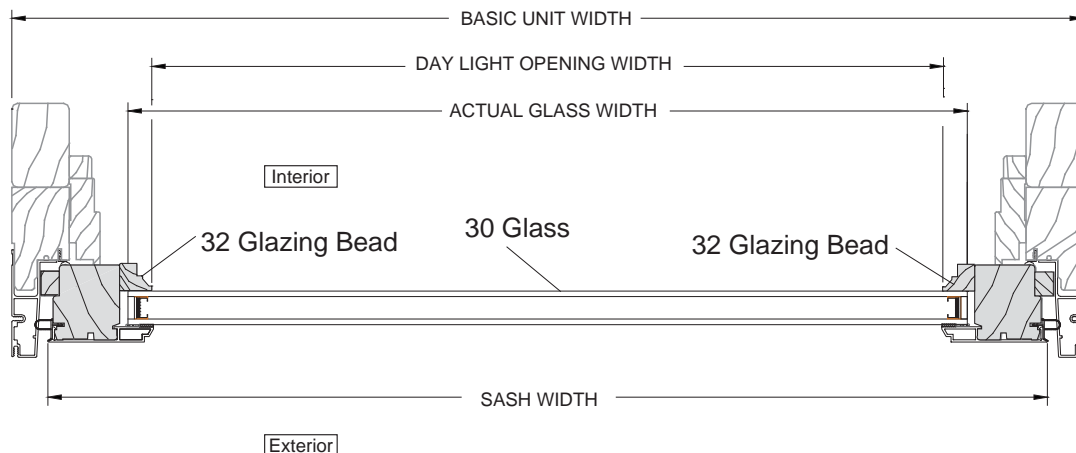

Sash Exploded View for Stationary Picture Sash N' Frame

Picture Sash Glass Sizes

35x11	55x11
35x15	55x15
35x19	55x19
35x23	55x23
35x27	55x27
35x31	55x31
35x35	55x35
35x43	55x43
35x47	55x47
35x55	55x55
35x59	55x59
35x67	55x67
43x11	59x11
43x15	59x15
43x19	59x19
43x23	59x23
43x27	59x27
43x31	59x31
43x35	59x35
43x43	59x43
43x47	59x47
43x55	59x55
43x59	59x59
43x67	59x67
47x11	67x11
47x15	67x15
47x19	67x19
47x23	67x23
47x27	67x27
47x31	67x31*
47x35	67x35
47x43	67x43
47x47	67x47
47x55	67x55
47x59	67x59
47x67	67x67

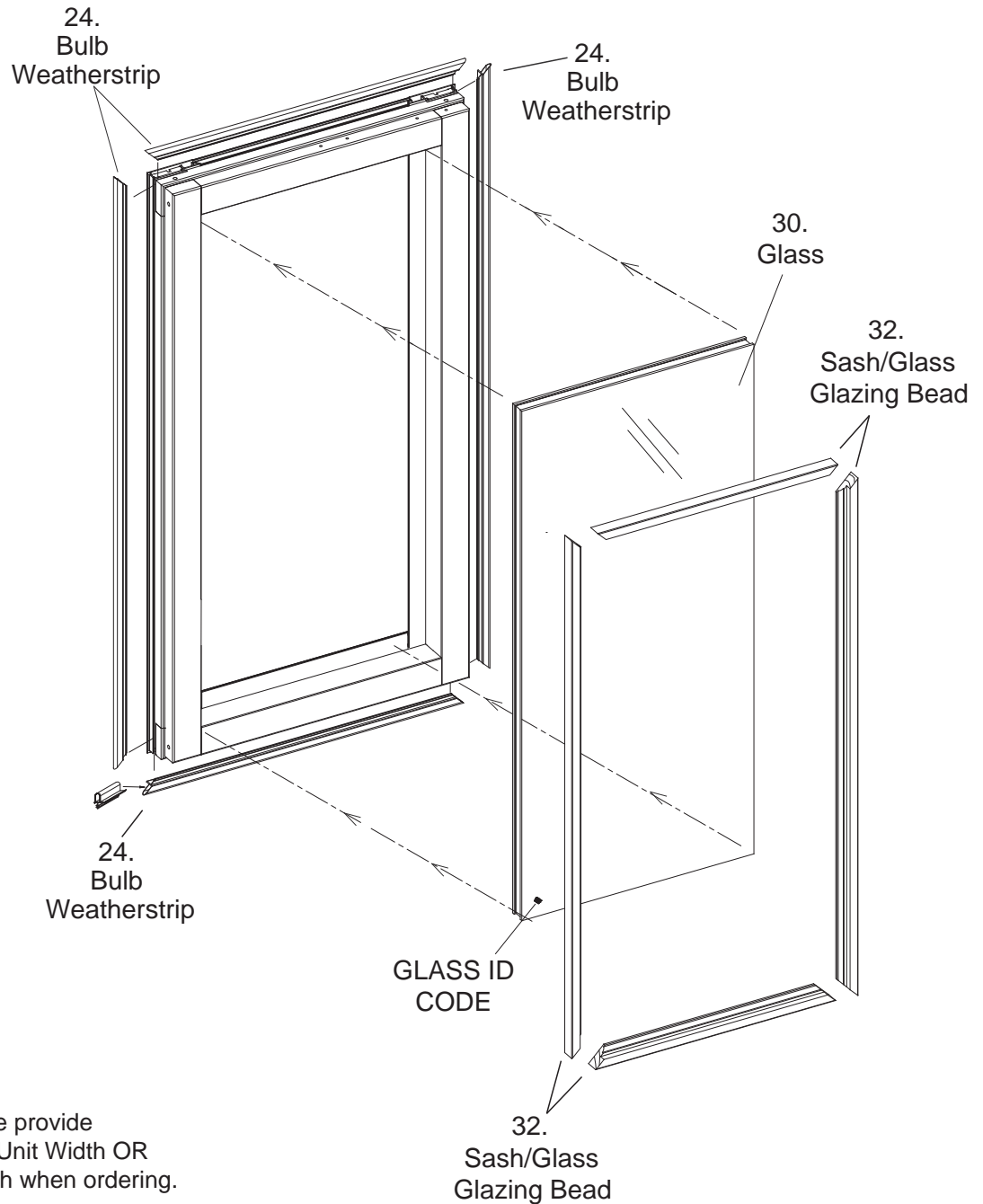

Complete Sash

Please note:
For Complete Sash, please provide
Basic Unit Height & Basic Unit Width OR
Glass Height & Glass Width when ordering.
See Page CCSE-19.

Note: Operating Sash Exploded View can be seen on Page CCSE-3.

Clad Wood Casement Windows Replacement Parts



Glazing Beads

Glazing Beads 9-17-2007 & Prior

Item No.	Description	Part No.
Not Shown on Exploded Views	3MM Glass	
	L/F _____	211876
	4MM Glass	
	L/F _____	211875
	6MM Glass	
	L/F _____	211874

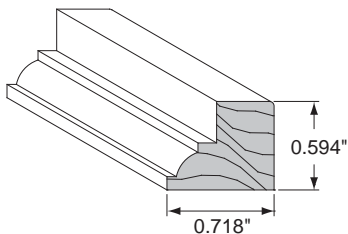

Used on 3MM GLASS

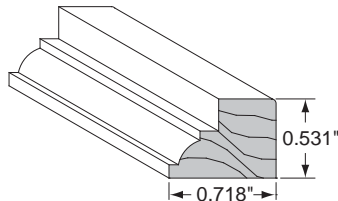

Used on 4MM GLASS

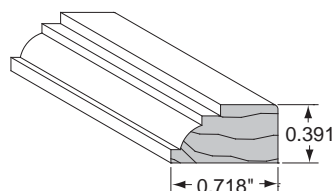

Used on 6MM GLASS

Glazing Beads 9-17-2007 to Present

Item No.	Description	Part No.	
32.	3MM & 4MM Glass		
	11 Glass Size _____	216695	
	15 Glass Size _____	216696	
	19 Glass Size _____	216697	
	23 Glass Size _____	216698	
	27 Glass Size _____	216699	
	31 Glass Size _____	216700	
	35 Glass Size _____	216701	
	43 Glass Size _____	216702	
	47 Glass Size _____	216703	
	55 Glass Size _____	216704	
	59 Glass Size _____	216705	
	67 Glass Size _____	216706	
	L/F _____	216940	
		6MM Glass	
	11 Glass Size _____	216707	
15 Glass Size _____	216708		
19 Glass Size _____	216709		
23 Glass Size _____	216710		
27 Glass Size _____	216711		
31 Glass Size _____	216712		
35 Glass Size _____	216713		
43 Glass Size _____	216714		
47 Glass Size _____	216715		
55 Glass Size _____	216716		
59 Glass Size _____	216717		
67 Glass Size _____	216718		
L/F _____	216941		

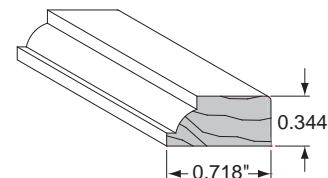
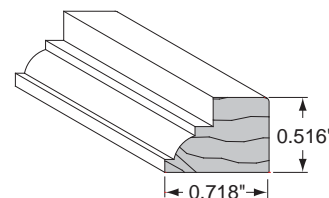

Note: Parts drawings not to scale.

Screens, w/Lift Rail 01/1998 to Present

Item No.	Description	Glass Size	Part No.			
			<u>White</u>	<u>Gold</u>	<u>03 Bronze</u>	
31.	11 CCSE Screen	11.00 x 27.00	070141	070093	093734	
		11.00 x 31.00	070142	070094	093735	
		11.00 x 35.00	070143	070095	093736	
		11.00 x 43.00	070144	070096	093737	
		11.00 x 47.00	070166	070118	093738	
		11.00 x 55.00	070167	070119	093739	
		11.00 x 59.00	070168	070120	093740	
		11.00 x 67.00	070149	070100	093741	
		15 CCSE Screen	15.00 x 19.00	070475	070092	093742
			15.00 x 23.00	010224	010233	093743
15.00 x 27.00	070124		070073	093744		
15.00 x 31.00	070125		070074	093745		
15.00 x 35.00	070126		070075	093746		
15.00 x 43.00	070127		070084	093747		
15.00 x 47.00	070150		070101	093748		
15.00 x 55.00	070151		070109	093749		
15.00 x 59.00	070152		070102	093750		
15.00 x 67.00	070153		070115	093751		
19 CCSE Screen	19.00 x 15.00	070176	070087	N/A		
	19.00 x 19.00	070145	070091	093752		
	19.00 x 23.00	010036	021803	093753		
	19.00 x 27.00	070128	070076	093754		
	19.00 x 31.00	070129	070077	093755		
	19.00 x 35.00	070130	070078	093756		
	19.00 x 43.00	070131	070085	093757		
	19.00 x 47.00	070154	070103	093758		
	19.00 x 55.00	070155	070110	093759		
	19.00 x 59.00	070156	070104	093760		
23 CCSE Screen	23.00 x 23.00	070157	070133	093761		
	23.00 x 27.00	010527	010531	093762		
	23.00 x 31.00	070132	070079	093763		
	23.00 x 35.00	070133	070080	093764		
	23.00 x 43.00	070134	070081	093765		
	23.00 x 47.00	070135	070086	093766		
	23.00 x 55.00	070158	070105	093767		
	23.00 x 59.00	070159	070111	093768		
	23.00 x 67.00	070160	070106	093769		
	23.00 x 67.00	070161	070116	093770		
27 CCSE Screen	27.00 x 27.00	070136	070088	093771		
	27.00 x 31.00	070137	070089	093772		
	27.00 x 35.00	070138	070082	093773		
	27.00 x 43.00	070139	070083	093774		
	27.00 x 47.00	070162	070108	093775		
	27.00 x 55.00	070163	070112	093776		
	27.00 x 59.00	070164	070114	093777		
	27.00 x 67.00	070165	070117	093778		
31 CCSE Screen	31.00 x 27.00	070145	070097	N/A		
	31.00 x 31.00	070140	070090	093779		
	31.00 x 35.00	070147	070098	093780		
	31.00 x 43.00	070148	070099	093781		
	31.00 x 47.00	070169	070121	093782		
	31.00 x 55.00	070170	070122	093783		
	31.00 x 59.00	070171	070123	093784		
	31.00 x 67.00	070172	070107	093785		

Note: For screens with lift tabs, please specify screen width and screen height.

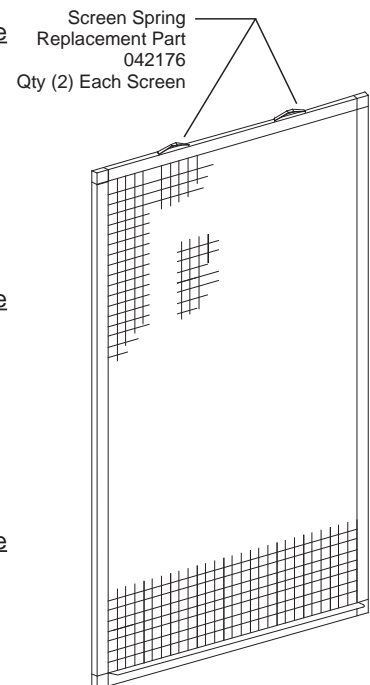
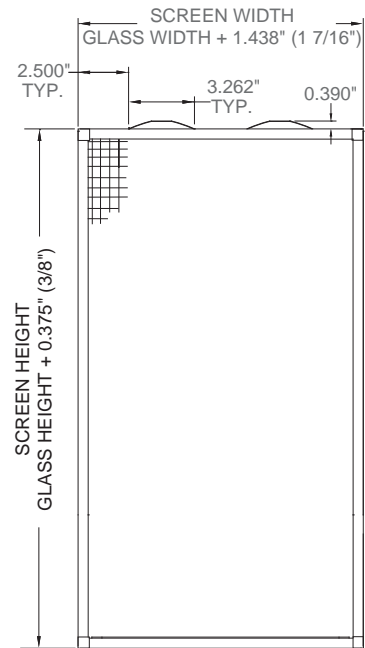

Note: Parts drawings not to scale.

Clad Wood Casement Windows Replacement Parts



Screens w/Plunger From 1998 & Prior

Item No.	Description	Glass Size	Part No.	
			White	Gold
Not Shown on Exploded Views	11 CSE Screen	11.00 x 27.00	035052	035039
		11.00 x 31.00	035053	035040
		11.00 x 35.00	035054	035041
		11.00 x 43.00	035055	035042
		11.00 x 47.00	035056	035043
		11.00 x 55.00	035057	035044
		11.00 x 59.00	035058	035045
		11.00 x 67.00	010290	010286
15 CSE Screen	15.00 x 19.00	15.00 x 19.00	N/A	022444
		15.00 x 23.00	N/A	N/A
		15.00 x 27.00	019240	010476
		15.00 x 31.00	019241	010477
		15.00 x 35.00	019242	010478
		15.00 x 43.00	019243	010774
		15.00 x 47.00	019244	010480
		15.00 x 55.00	019245	011760
		15.00 x 59.00	019246	010481
		15.00 x 67.00	019247	013396
19 CSE Screen	19.00 x 15.00	19.00 x 15.00	N/A	N/A
		19.00 x 19.00	039380	021046
		19.00 x 23.00	N/A	N/A
		19.00 x 27.00	019248	010483
		19.00 x 31.00	019249	010484
		19.00 x 35.00	019250	010485
		19.00 x 43.00	019251	010775
		19.00 x 47.00	019252	010487
		19.00 x 55.00	019253	010761
		19.00 x 59.00	019254	010488
23 CSE Screen	23.00 x 23.00	23.00 x 23.00	N/A	N/A
		23.00 x 27.00	019256	010490
		23.00 x 31.00	019257	010491
		23.00 x 35.00	019258	010492
		23.00 x 43.00	019259	010776
		23.00 x 47.00	019260	010494
		23.00 x 55.00	019261	011762
		23.00 x 59.00	019262	010495
27 CSE Screen	27.00 x 27.00	27.00 x 27.00	019263	013397
		27.00 x 31.00	019264	013398
		27.00 x 35.00	019265	013399
		27.00 x 43.00	019266	010515
		27.00 x 47.00	019267	010553
		27.00 x 55.00	019268	010828
		27.00 x 59.00	019269	011819
		27.00 x 67.00	019270	013101
31 CSE Screen	31.00 x 27.00	31.00 x 27.00	019271	013400
		31.00 x 31.00	N/A	N/A
		31.00 x 35.00	019280	018151
		31.00 x 43.00	038540	039533
		31.00 x 47.00	039541	039534
		31.00 x 55.00	039542	039535
		31.00 x 59.00	039543	039536
		31.00 x 67.00	039544	039537
			011371	010556

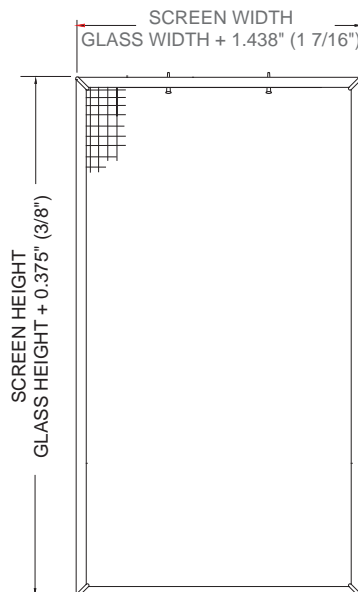

Tech Tip:
Plunger style screens will fit all Casement windows, regardless of manufacture date.

Lift Rail type screens are not interchangeable with Plunger style screens made 1998 to Prior.



CSE White Spring Screen Cap
Part# 025689



CSE Black Spring Screen Cap
Part# 025708



CSE Screen Spring
Part# 025688



Screen Plunger
Part# 025687

Note: Parts drawings not to scale.



Clad Wood Casement Windows Replacement Parts

Glass, 02/18/03 & Prior

Glazing Tape

• Glazing Beads can be Found on CCSE-22.

- 1/16" x 1/2" Black Foam Glazing Tape (200' Per Roll) _____ 013303 L/F
- 1/16" x 1/2" Roll of Black Foam Glazing Tape _____ 011831 Roll

Replacement Glass for

Units Manufactured BEFORE February 19, 2003

<u>1" Insulating Glass</u>		<u>1" Low-E Insulating Glass</u>	
Part#	Part#	Part#	Part#
11 x 27 Glass 515050	31 x 31 Glass 511050	11 x 27 Glass 515086	31 x 31 Glass 512926
11 x 31 Glass 515051	31 x 35 Glass 511041	11 x 31 Glass 515087	31 x 35 Glass 512927
11 x 35 Glass 515052	31 x 43 Glass 511043	11 x 35 Glass 515088	31 x 43 Glass 512928
11 x 43 Glass 515053	31 x 47 Glass 511045	11 x 43 Glass 515089	31 x 47 Glass 512929
11 x 47 Glass 515054	31 x 55 Glass 511047	11 x 47 Glass 515090	31 x 55 Glass 512930
11 x 55 Glass 515055	31 x 59 Glass 511799	11 x 55 Glass 515091	31 x 59 Glass 512931
11 x 59 Glass 515056	31 x 67 Glass 511103	11 x 59 Glass 515092	31 x 67 Glass 512932
11 x 67 Glass 515131		11 x 67 Glass 515132	
	35 x 31 Glass 511041		35 x 31 Glass 512927
15 x 19 Glass 511792	35 x 35 Glass 510656	15 x 19 Glass 512885	35 x 35 Glass 512933
15 x 23 Glass 511795	35 x 43 Glass 510385	15 x 23 Glass 512886	35 x 43 Glass 512934
15 x 27 Glass 510459	35 x 47 Glass 510386	15 x 27 Glass 512887	35 x 47 Glass 512935
15 x 31 Glass 510634	35 x 55 Glass 510408	15 x 31 Glass 512888	35 x 55 Glass 512936
15 x 35 Glass 510460	35 x 59 Glass 510387	15 x 35 Glass 512889	35 x 59 Glass 512937
15 x 43 Glass 510463	35 x 67 Glass 511042	15 x 43 Glass 512890	35 x 67 Glass 512938
15 x 47 Glass 510636		15 x 47 Glass 512891	
15 x 55 Glass 510637	43 x 31 Glass 511043	15 x 55 Glass 512892	43 x 31 Glass 512928
15 x 59 Glass 511051	43 x 35 Glass 510385	15 x 59 Glass 512893	43 x 35 Glass 512934
15 x 67 Glass 510638	43 x 43 Glass 510388	15 x 67 Glass 512894	43 x 43 Glass 512939
	43 x 47 Glass 510389		43 x 47 Glass 512940
19 x 19 Glass 511712	43 x 55 Glass 510409	19 x 19 Glass 512896	43 x 55 Glass 512941
19 x 23 Glass 511810	43 x 59 Glass 510390	19 x 23 Glass 512897	43 x 59 Glass 512942
19 x 27 Glass 510465	43 x 67 Glass 511044	19 x 27 Glass 512898	43 x 67 Glass 512943
19 x 31 Glass 510467		19 x 31 Glass 512899	
19 x 35 Glass 510469	47 x 31 Glass 511045	19 x 35 Glass 512900	47 x 31 Glass 512929
19 x 43 Glass 510662	47 x 35 Glass 510386	19 x 43 Glass 512901	47 x 35 Glass 512935
19 x 47 Glass 510640	47 x 43 Glass 510389	19 x 47 Glass 512902	47 x 43 Glass 512940
19 x 55 Glass 510623	47 x 47 Glass 510391	19 x 55 Glass 512903	47 x 47 Glass 512944
19 x 59 Glass 511039	47 x 55 Glass 510657	19 x 59 Glass 512904	47 x 55 Glass 512945
19 x 67 Glass 510624	47 x 59 Glass 510392	19 x 67 Glass 512905	47 x 59 Glass 512946
	47 x 67 Glass 511046		47 x 67 Glass 512947
23 x 23 Glass 511797		23 x 23 Glass 512907	
23 x 27 Glass 510641	55 x 31 Glass 511047	23 x 27 Glass 512908	55 x 31 Glass 512930
23 x 31 Glass 510642	55 x 35 Glass 510408	23 x 31 Glass 512909	55 x 35 Glass 512936
23 x 35 Glass 510625	55 x 43 Glass 510409	23 x 35 Glass 512910	55 x 43 Glass 512941
23 x 43 Glass 510626	55 x 47 Glass 510657	23 x 43 Glass 512911	55 x 47 Glass 512945
23 x 47 Glass 510643	55 x 55 Glass 510410	23 x 47 Glass 512912	55 x 55 Glass 512948
23 x 55 Glass 510627	55 x 59 Glass 511048	23 x 55 Glass 512913	55 x 59 Glass 512949
23 x 59 Glass 511040	55 x 67 Glass 511049	23 x 59 Glass 512914	55 x 67 Glass 512950
23 x 67 Glass 510644		23 x 67 Glass 512915	
	59 x 31 Glass 511799		59 x 31 Glass 512931
27 x 27 Glass 510684	59 x 35 Glass 510387	27 x 27 Glass 512917	59 x 35 Glass 512937
27 x 31 Glass 510685	59 x 43 Glass 510390	27 x 31 Glass 512918	59 x 43 Glass 512942
27 x 35 Glass 510686	59 x 47 Glass 510392	27 x 35 Glass 512919	59 x 47 Glass 512946
27 x 43 Glass 510687	59 x 55 Glass 511049	27 x 43 Glass 512920	59 x 55 Glass 512949
27 x 47 Glass 510688	59 x 59 Glass 510393	27 x 47 Glass 512921	59 x 59 Glass 512951
27 x 55 Glass 510689	59 x 67 Glass 511102	27 x 55 Glass 512922	59 x 67 Glass 512952
27 x 59 Glass 511052		27 x 59 Glass 512923	
27 x 67 Glass 510644	67 x 31 Glass 511103	27 x 67 Glass 512924	67 x 31 Glass 512932
	67 x 35 Glass 511042		67 x 35 Glass 512938
	67 x 43 Glass 511044		67 x 43 Glass 512943
	67 x 47 Glass 511044		67 x 47 Glass 512947
	67 x 55 Glass 511046		67 x 55 Glass 512950
	67 x 59 Glass 511102		67 x 59 Glass 512952
	67 x 67 Glass 511826		67 x 67 Glass 512953

* Glass must be tempered.

Clad Wood Casement Windows Replacement Parts



Glass, 02/19/03 to Present

Glazing Tape

- 1/16" x 1/2" Black Foam Glazing Tape (200' Per Roll) _____ 013303 L/F
- 1/16" x 1/2" Roll of Black Foam Glazing Tape _____ 011831 Roll
- Glazing Beads can be Found on CCSE-22.

**Replacement Glass for
Units Manufactured AFTER February 19, 2003**

<u>3MM Insulating Glass</u>				<u>3MM Low-E Insulating Glass</u>			
	Part#		Part#		Part#		Part#
11 x 27 Glass	515041	31 x 31 Glass	511496	11 x 27 Glass	517591	31 x 31 Glass	517617
11 x 31 Glass	515042	31 x 35 Glass	511497	11 x 31 Glass	517592	31 x 35 Glass	517618
11 x 35 Glass	515043	31 x 43 Glass	511802	11 x 35 Glass	517593	31 x 43 Glass	517619
11 x 43 Glass	515044	31 x 47 Glass	511803	11 x 43 Glass	517594	31 x 47 Glass	517704
11 x 47 Glass	515045	31 x 55 Glass	511804	11 x 47 Glass	517689	31 x 55 Glass	517705
11 x 55 Glass	515046	31 x 59 Glass	511805	11 x 55 Glass	517690	31 x 59 Glass	517706
11 x 59 Glass *	515047	31 x 67 Glass *	511806	11 x 59 Glass *	517691	31 x 67 Glass *	517707
11 x 67 Glass *	515860			11 x 67 Glass *	521347		
		35 x 31 Glass	511497			35 x 31 Glass	517618
15 x 19 Glass	512273	35 x 35 Glass	511480	15 x 19 Glass	517596	35 x 35 Glass	517708
15 x 23 Glass	512248	35 x 43 Glass	511481	15 x 23 Glass	517597	35 x 43 Glass	517620
15 x 27 Glass	511350	35 x 47 Glass	511482	15 x 27 Glass	517598	35 x 47 Glass	517709
15 x 31 Glass	511351			15 x 31 Glass	517599		
15 x 35 Glass	511352	43 x 31 Glass	511802	15 x 35 Glass	517600	43 x 31 Glass	517619
15 x 43 Glass	511353	43 x 35 Glass	511481	15 x 43 Glass	517601	43 x 35 Glass	517620
15 x 47 Glass	511354	43 x 43 Glass	511485	15 x 47 Glass	517692	43 x 43 Glass	517713
15 x 55 Glass	511355			15 x 55 Glass	517693		
15 x 59 Glass	511503	47 x 31 Glass	511803	15 x 59 Glass	517694	47 x 31 Glass	517704
15 x 67 Glass	511356	47 x 35 Glass	511482	15 x 67 Glass	517695	47 x 35 Glass	517709
19 x 19 Glass	511495	55 x 31 Glass	511804	19 x 19 Glass	517602	55 x 31 Glass	517705
19 x 23 Glass	512275			19 x 23 Glass	517603		
19 x 27 Glass	511357	59 x 31 Glass	511805	19 x 27 Glass	517604	59 x 31 Glass	517706
19 x 31 Glass	511358			19 x 31 Glass	517605		
19 x 35 Glass	511359	67 x 31 Glass *	511806	19 x 35 Glass	517606	67 x 31 Glass *	517707
19 x 43 Glass	511360			19 x 43 Glass	517607		
19 x 47 Glass	511361			19 x 47 Glass	517724		
19 x 55 Glass	511362			19 x 55 Glass	517725		
19 x 59 Glass	511504			19 x 59 Glass	517726		
19 x 67 Glass	511363			19 x 67 Glass	517727		
23 x 23 Glass	512276			23 x 23 Glass	517608		
23 x 27 Glass	511364			23 x 27 Glass	517609		
23 x 31 Glass	511365			23 x 31 Glass	517610		
23 x 35 Glass	511366			23 x 35 Glass	517611		
23 x 43 Glass	511367			23 x 43 Glass	517612		
23 x 47 Glass	511368			23 x 47 Glass	517696		
23 x 55 Glass	511369			23 x 55 Glass	517697		
23 x 59 Glass	511505			23 x 59 Glass	517698		
23 x 67 Glass	511370			23 x 67 Glass	517699		
27 x 27 Glass	511371			27 x 27 Glass	517613		
27 x 31 Glass	511372			27 x 31 Glass	517614		
27 x 35 Glass	511373			27 x 35 Glass	517615		
27 x 43 Glass	511374			27 x 43 Glass	517616		
27 x 47 Glass	511375			27 x 47 Glass	517700		
27 x 55 Glass	511376			27 x 55 Glass	517701		
27 x 59 Glass	511506			27 x 59 Glass	517702		
27 x 67 Glass	511377			27 x 67 Glass	517703		

* Glass must be tempered.



Clad Wood Casement Windows Replacement Parts

Picture Glass, 02/18/03 to Present

Glazing Tape

- 1/16" x 1/2" Black Foam Glazing Tape (200' Per Roll) ————— 013303 L/F
- 1/16" x 1/2" Roll of Black Foam Glazing Tape ————— 011831 Roll

Replacement Glass for

Units Manufactured AFTER February 19, 2003

Item No.

<u>30.</u>	<u>6MM Insulating Glass</u>		<u>Standard 6MM Low-E Insulating Glass</u>	
		<u>Part#</u>		<u>Part#</u>
	35 x 55 Glass	511483	35 x 55 Glass	517710
	35 x 59 Glass	511507	35 x 59 Glass	517711
	35 x 67 Glass	511484	35 x 67 Glass	517712
	43 x 47 Glass	511486	43 x 47 Glass	517714
	43 x 55 Glass	511487	43 x 55 Glass	517715
	43 x 59 Glass	511508	43 x 59 Glass	517716
	43 x 67 Glass	511488	43 x 67 Glass	517717
	47 x 43 Glass	511486	47 x 43 Glass	517714
	47 x 47 Glass	511489	47 x 47 Glass	517718
	47 x 55 Glass	511490	47 x 55 Glass	517719
	47 x 59 Glass	511509	47 x 59 Glass	517720
	47 x 67 Glass	511491	47 x 67 Glass	517721
	55 x 35 Glass	511483	55 x 35 Glass	517710
	55 x 43 Glass	511487	55 x 43 Glass	517715
	55 x 47 Glass	511490	55 x 47 Glass	517719
	55 x 55 Glass	511492	55 x 55 Glass	517722
	55 x 59 Glass	511510	55 x 59 Glass	517723
	55 x 67 Glass	511493	55 x 67 Glass	517686
	59 x 35 Glass	511507	59 x 35 Glass	517711
	59 x 43 Glass	511508	59 x 43 Glass	517716
	59 x 47 Glass	511509	59 x 47 Glass	517720
	59 x 55 Glass	511510	59 x 55 Glass	517723
	59 x 59 Glass	511722	59 x 59 Glass	522917
	59 x 67 Glass	511511	59 x 67 Glass	517687
	67 x 35 Glass	511484	67 x 35 Glass	517712
	67 x 43 Glass	511488	67 x 43 Glass	517717
	67 x 47 Glass	511491	67 x 47 Glass	517721
	67 x 55 Glass	511493	67 x 55 Glass	517686
	67 x 59 Glass	511511	67 x 59 Glass	517687
	67 x 67 Glass	511494	67 x 67 Glass	517688

- Glazing Beads can be Found on CCSE-22.

Clad Wood Casement Windows Replacement Parts



Grille Parts

Description	Where Used	Part No.
-------------	------------	----------

KD

NOTE: THE FOLLOWING PRODUCTS ARE ONLY AVAILBLE IN KD WITH SLIDE PINS.



5/8" Single Slide Pin _____ Part# 027382

TRADITIONAL Single Profile Grilles
FOR CIRCLE TOP UNITS
033B



5/8" Slide Pin _____ Part# 015917

TRADITIONAL Double Profile
026

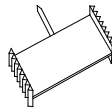

7/8" Slide Pin _____ Part# 015918

REGAL Double Profile
028

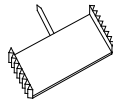

1" Single Slide Pin _____ Part# 027383

REGAL Single Profile Grilles
FOR CIRCLE TOP UNITS
028B

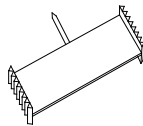

1-7/16" Slide Pin _____ Part # 017850

SUPER REGAL Profile Prior to 05/07/02
046

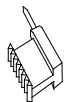

T-Route Pin (Elliptical) _____ Part# 026720

TRADITIONAL/REGAL Double/Single Profile Grilles
FOR ELLIPSE UNITS
034G



Concealed KD Clip _____ Part# 011804

REGAL/TRADITIONAL Single Profile Grilles
FOR RECTANGLE WINDOW UNITS:
CLASSIC CSE PRODUCTS PRIOR TO 04/29/02
& DIRECT SET.
1216

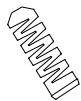

Plastic Spring Fastener _____ Part# 026721

Note: Parts drawings not to scale.

Grille Parts

Description	Where Used	Part No.
-------------	------------	----------

SURROUNDS



Grille Push Pin ————— Part# 015916
REGAL/TRADITIONAL Single/Double Profile Grilles
For Direct Set & Circle Top Units
014



Grille Grommet ————— Part# 015915
REGAL/TRADITIONAL Single/Double Profile Grilles
For Direct Set & Circle Top Units
016



Snap-In Full Surround Grille Clip ————— Part# 013140
REGAL/TRADITIONAL Single Profile Grilles
TAPE GLAZED UNITS
(EFFECTIVE 01-01-98)
1212



SNAP-IN TAPE GLAZE GRILLE CLIP 026766
REGAL/TRAD SINGLE/DBL PROFILE
(REPLACED WITH ABOVE CLIP 013140)



Snap-In Putty Glaze Grille Clip ————— Part# 072013
REGAL/TRADITIONAL Single Profile Grilles
FOR PUTTY GLAZED UNITS
(EFFECTIVE 01-01-98)
1213



SNAP-IN PUTTY GLAZE GRILLE CLIP 026765
REGAL/TRAD SINGLE/DBL PROFILE
(REPLACED WITH ABOVE CLIP 072013)



Snap-In Full Surround Grille Clip ————— Part# 092890
GRILLES FOR BUILDERS, ENERGY SAVER
1203



FRICITION FIT
(OBSOLETE AS OF 10-17-94)

Note: Parts drawings not to scale.

Clad Wood Casement Windows Replacement Parts



Service Kit & Supplies

Description	Part No.
<u>1/8" x 1-1/2" x 3/4" Neoprene Glass Setting Block</u>	Part# 016158
<u>Divided Lite Grille Tape</u>	
• 1/32" x 1" Roll of Black Foam Glazing Tape (300' Per Roll)	025973 L/F
• 1/16" x 1" Roll of Black Foam Glazing Tape (150' Per Roll)	025975 L/F
• 1/8" x 1" Roll of Black Foam Tape (75' Per Roll)	035030 L/F

Fastener Schedule

Note: Parts drawings not to scale.

Part No.	Description	QTY.	Where Used
<u>Screws</u>			
085425	#6 x 5/8" PH Truss HD Screw	2	Limit Device Slide to Sash
011636	#6 X 5/8" PH PAN HD BRZ SM Screw	2 / Retainer	Tie Bar Retainer
039051	#6 x 2-3/4" PH FH S.S. Screw	As Required	Wood Astragal to Sash
013801	#7 x 1/2" PH FL 100 Degree Head SS SMS	As Required	Fasten Corner Keys to Frame / Hinge Tracks / Limit Device to Frame / Frame Snubber
099285	#7 x 7/8" PH FL HD S.S. Screw	3	Sash Brackets to Sash
025969	#8 x 1-3/4" PH FL HD SM Zinc Screw	As Required	Head and Seat Boards to Jambs
011836	#6 x 2-3/4" PH FL HD WD Z & Y Screw	As Required	Stationary Sash
<u>Nails</u>			
092748	1-1/2" Ring Shank Nail	8" Apart	Head Stop to Head Jamb / Side Stop to Side Jamb
010226	Auto Nail Wire	As Required	Sill Ext. to Sill Jamb
035029	14 X 2-1/2" T-Nail	2 / Corner	Pin Sash Corners
011824	16 X 1-3/4" T-Nail	6	Sill Cover to Sill
011824	16 X 1-3/4" T-Nail	4	Lower Sill Section to Sill
096274	18 x 1-1/4" T-Nail	As Required	Fasten Glazing Bead to Sash
024617	14 x 2-1/2" 1/ Crown Staple	As Required	Side Ext. to Side Jamb / Head Ext. to Head Jamb
014692	16 x 5/8" GSI Staple	As Required	Gusset Strip to Top and Bottom of Mull
010521	16 x 2" Staple	12	Pin Frame Corners
094050	18 x 3/8 x 1/2" Staple	As Required	Aluminum Brick Mould
019892	18 x 1/2" GSN Staple	As Required	Metal Frame to Wood Frame / Arch Top Rail Metal Application
035038	18 x 1-1/4" GSN Staple	As Required	Buildup to Side Ext. and Head or Sill Ext.
<u>Corrugated Fastener</u>			
010659	3/4" Corrugated Fastener	As Required	Mull Side Jambs Together
022016	Schnee Moorhead 5731	As Required	Sash Glazing / Sash Metal Application

Touch Up Paint

Aluminum Touch-Up Paint - 16 oz. Spray Can

- White 047041
- Eggshell 047035
- Sand 047040
- Bronze 047031
- Brick Red 047030
- Green 047036
- Jet Black 047037
- Sage Brown 047039
- Burnt Sun 047032
- Dried Wheat 047034
- Aspen Moss 047027
- Patina Green 047038
- Boysenberry 047029
- Colonial White 047033
- Bahama Brown 047028

Aluminum Touch-Up Paint - 2oz Brush Bottles

- White 047056
- Eggshell 047050
- Sand 047055
- Bronze 047055
- Brick Red 047045
- Green 047051
- Jet Black 047052
- Sage Brown 047054
- Burnt Sun 047047
- Dried Wheat 047049
- Aspen Moss 047042
- Patina Green 047053
- Boysenberry 047044
- Colonial White 047048
- Bahama Brown 047043

Aluminum Touch-Up Paint - 0.6 oz. Liquid Brush On

- White Cladding 039613
- Bronze Cladding 039614
- Sand Cladding 039615
- Green Cladding 039616
- Eggshell Cladding 039576
- Brick Red Cladding 039572
- Gold - Screen Frame 039539
- White - Screen Frame 010016

Anodized Aluminum 2 oz. Touch-Up Paint

- Clear Anodized 098562
- Champagne Anodized 098563
- Light Bronze Anodized 098564
- Medium Bronze Anodized 098565
- Dark Bronze Anodized 098566

Clad Wood Casement Windows Replacement Parts



Notes

APPLICATION OF THE CASMENT LIMIT DEVICE
Allows sash to open a maximum of 4".

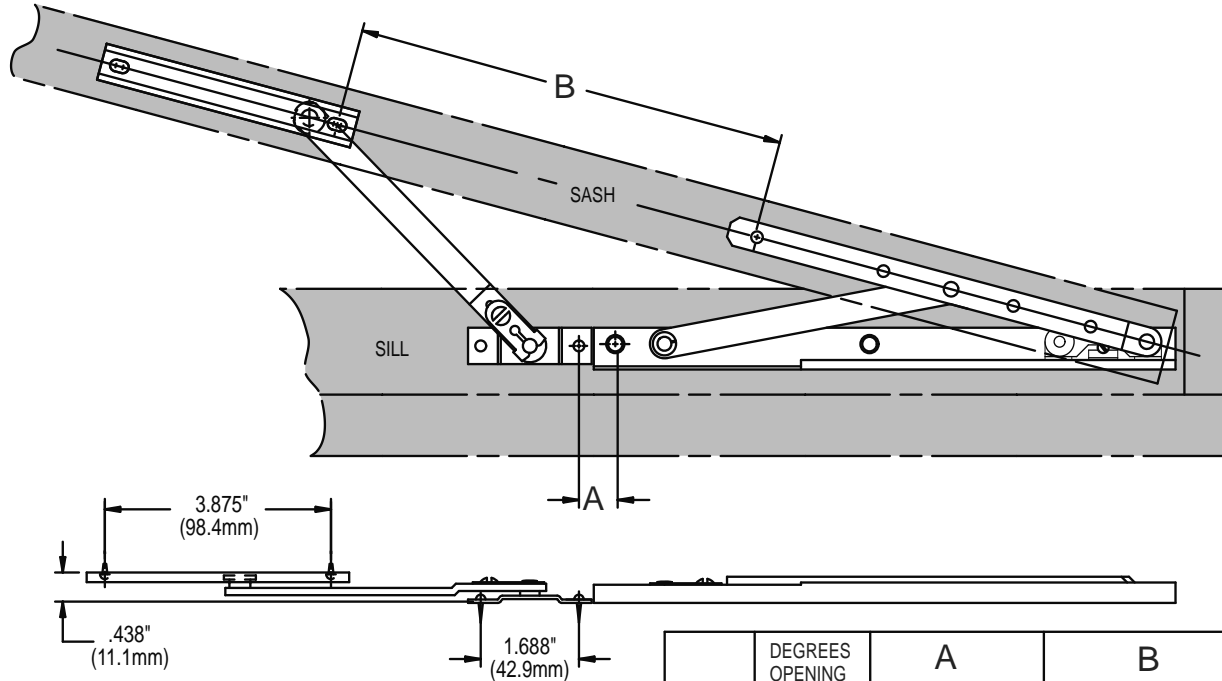

NOTE: MOUNTING DIMENSIONS MAY VARY WHEN USED WITH OTHER TYPES OF HINGES.

	DEGREES OPENING	A	B
10" HINGE	5	6.125 (155.6mm)	14.188 (360.4mm)
	10	.625 (15.9mm)	8.375 (212.7mm)
	15	.625 (15.9mm)	7.656 (194.5mm)
	20	.625 (15.9mm)	6.625 (168.3mm)
13" HINGE	5	6.125 (155.6mm)	14.250 (362.0mm)
	10	.625 (15.9mm)	11.344 (288.1mm)
	15	.625 (15.9mm)	10.156 (258.0mm)
	20	.625 (15.9mm)	8.313 (211.2mm)